



**Aprendendo com Falhas e
Acidentes nas Estruturas de
Concreto**

Paulo Helene
*Diretor PhD Engenharia
Prof. Titular Universidade de São Paulo USP
Conselheiro Instituto Brasileiro do Concreto IBRACON
Member fib(CEB-FIP) Service Life of Concrete Structures
Presidente ALCONPAT*



Rio de Janeiro 25 de novembro de 2011 Rossi Residencial

1

**Erros, Falhas,
Omissões, Colapsos,
Acidentes, Frustrações,
Atrasos, Retrabalho,
Constrangimentos,
Decepções, Vergonha...**

2

**“Duro”
Aprendizado!**

3

**“Duro”
Aprendizado!**
vitórias/soluções/desafios

4

Robert Stephenson discurso de posse presidência Instituto dos Engenheiros Civis da Grã-Bretanha. 1856:

“...tenho esperança de que todos os acidentes e problemas que tem ocorrido nos últimos anos sejam registrados e divulgados.

Nada é tão instrutivo para jovens e experientes engenheiros como o estudo dos acidentes e da sua correção.

O diagnóstico desses acidentes, o entendimento dos mecanismos de ocorrência, é mais valioso que a descrição dos trabalhos bem sucedidos.

Com esse objetivo nobre é que proponho a catalogação , discussão e divulgação desses problemas através desta reconhecida Instituição...”

5

✓ Postura dos Organizadores deste evento

✓ com experiência de um CONSTRUTOR

✓ conhecimento de quem atende casos de colegas

✓ com a humildade de quem já errou...

6

✓ Postura dos Organizadores

✓ compareço aqui com experiência de um CONSTRUTOR

✓ conhecimento de quem atende casos de colegas

✓ com a humildade de quem já errou...

7

✓ Postura dos Organizadores

✓ com experiência de um CONSTRUTOR

✓ conhecimento de quem atende casos de colegas

✓ com a humildade de quem já errou...

8

✓ **Postura dos Organizadores**

✓ **com experiência de um
CONSTRUTOR**

✓ **conhecimento de quem atende
casos de colegas**

✓ **com a humildade de quem já
errou...**

9

Edifício Comercial

2009
fissuras em lajes
obra nova

10



11



Diagnóstico:
Mal posicionamento de armadura negativa das lajes adjacentes, sobre as vigas, devido a pisoteio durante a concretagem

12



13



14



15

Laje de 15cm de espessura :
 375kg/m^2

Dimensionada para 150kg/m^2

1 ano de idade

 A schematic diagram of a chair with a wooden seat and backrest, supported by four legs. The chair is positioned to the right of the text.

16



17

QUEM RECEBE o CONCRETO?

QUEM APLICA o CONCRETO?

Caso 1: bloco de fundação

350m³

$f_{ck} = 35\text{MPa}$

39 caminhões OK

**6 caminhões
com f_{ck} de 8MPa a 12MPa**

18



19



20

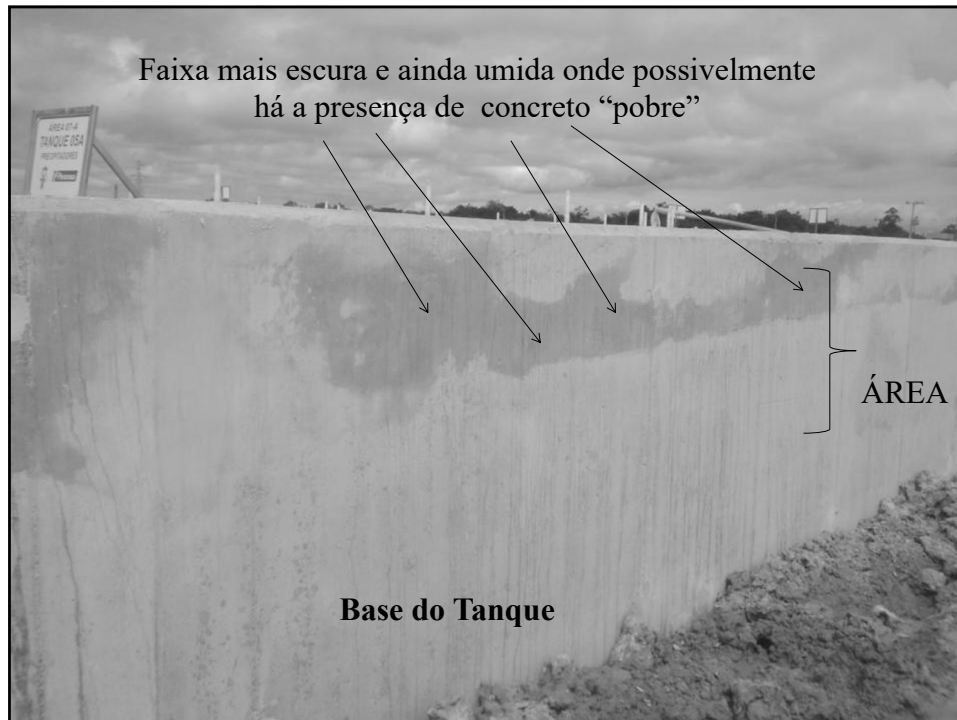

21

QUEM RECEBE o CONCRETO?

QUEM APLICA o CONCRETO?

Caso 2: edifício Diretoria da Construtora

8º andar

$f_{ck} = 40\text{MPa}$

1 caminhão com 10MPa

9 pilares!

22



23



24



25



26



27

seria um caso
de sabotagem
??? !!!

28

Dados do Edifício:**Localização: Rio de Janeiro, RJ.****36 pavimentos + 5 subsolos****Pilar P1 Esforços de projeto:****Normal: 1.253tf****Mx: 55tf.m****My: 8tf.m**

29

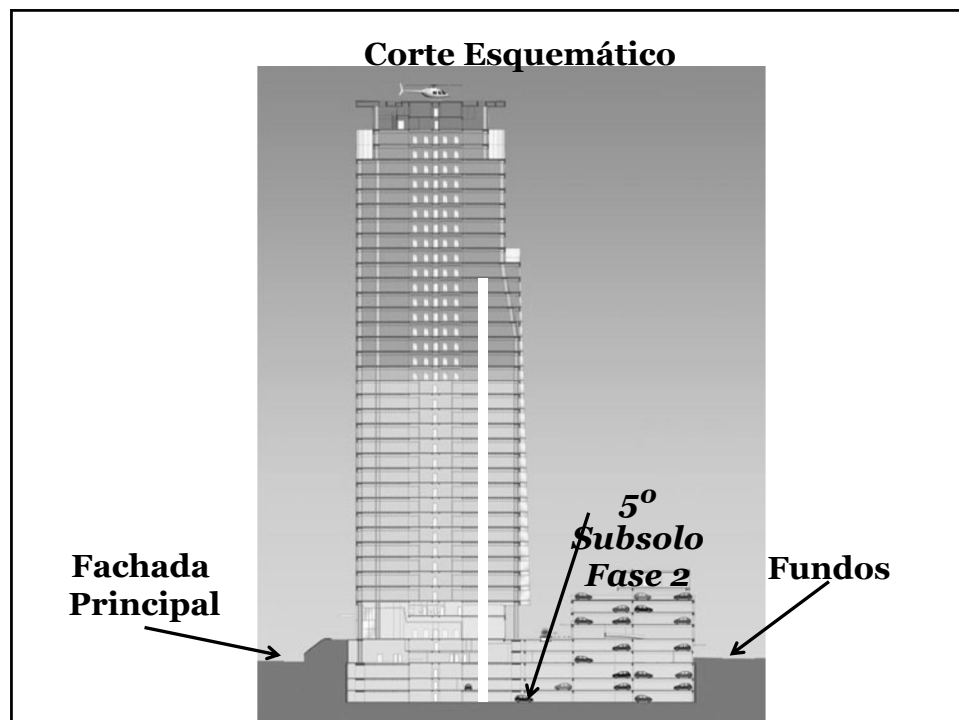

30

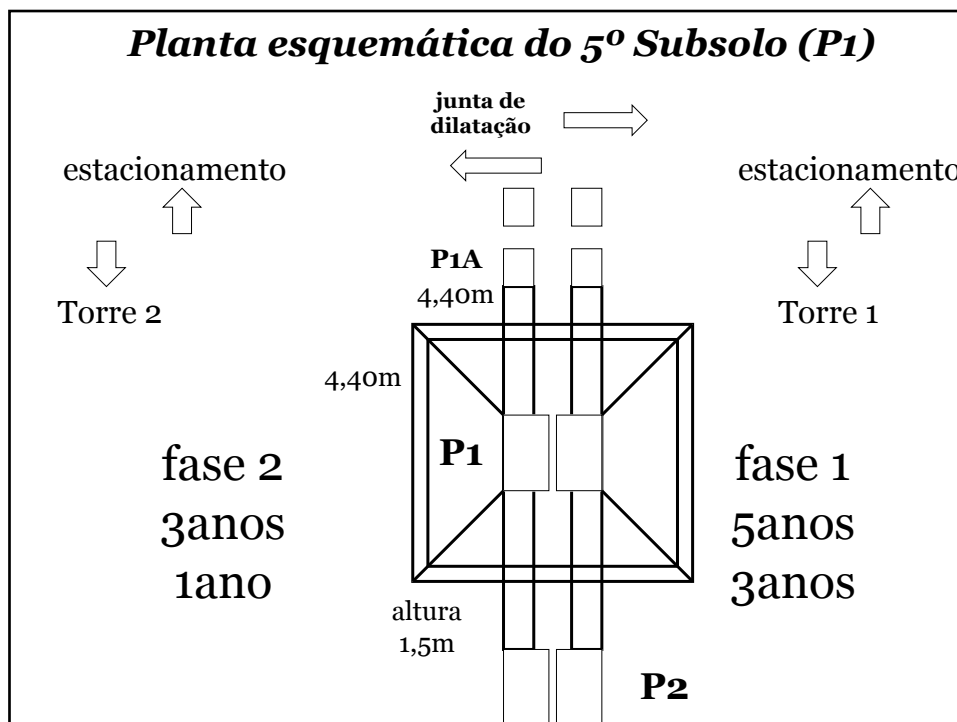

31

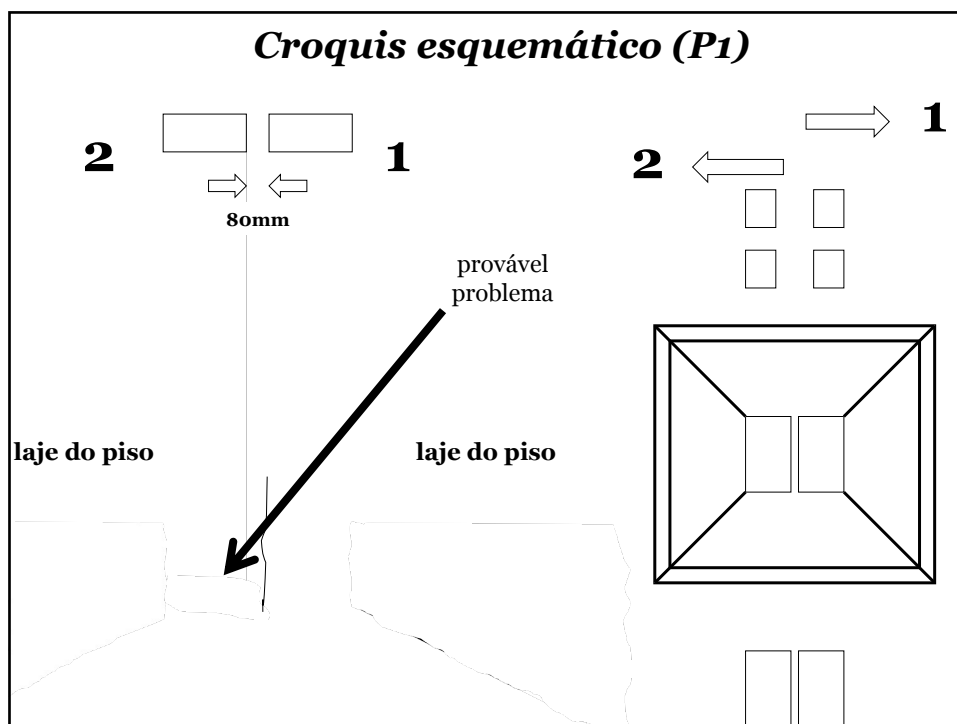

32

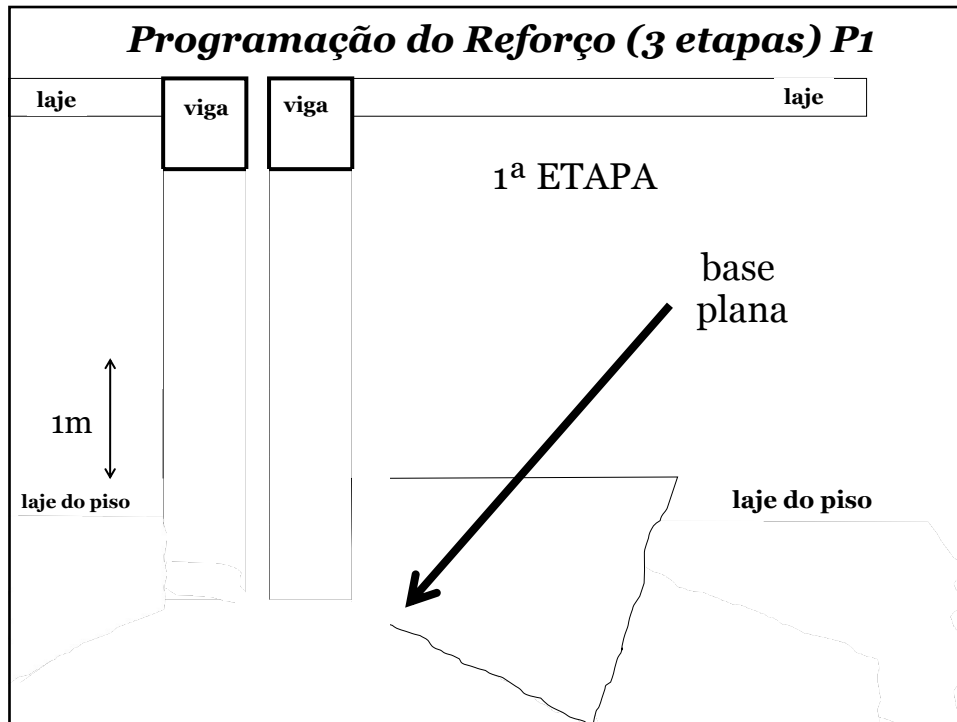

33

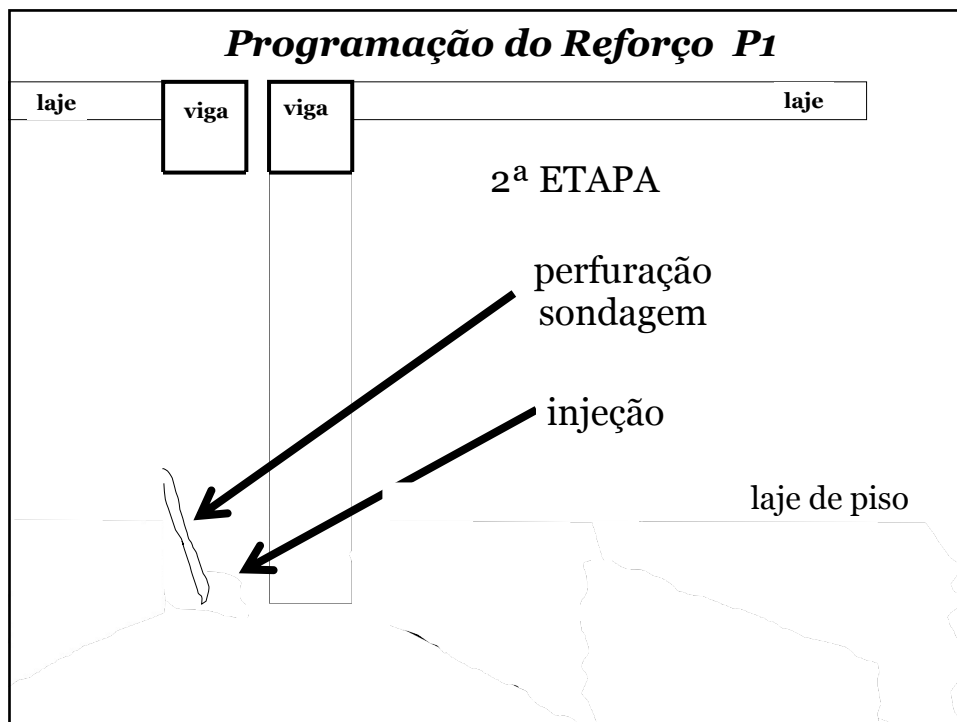

34

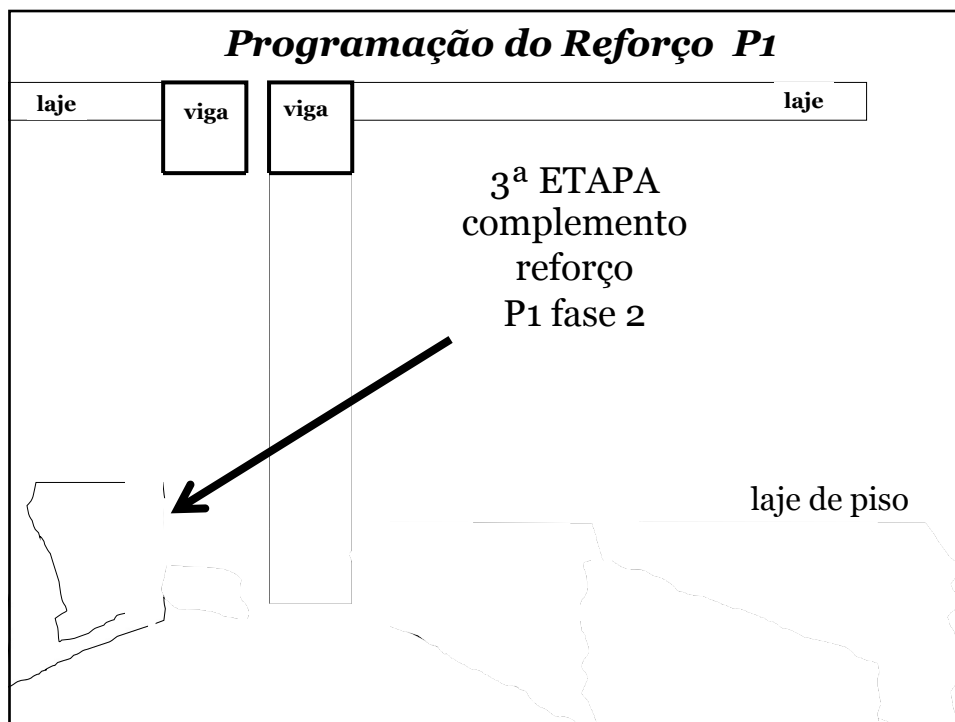

35

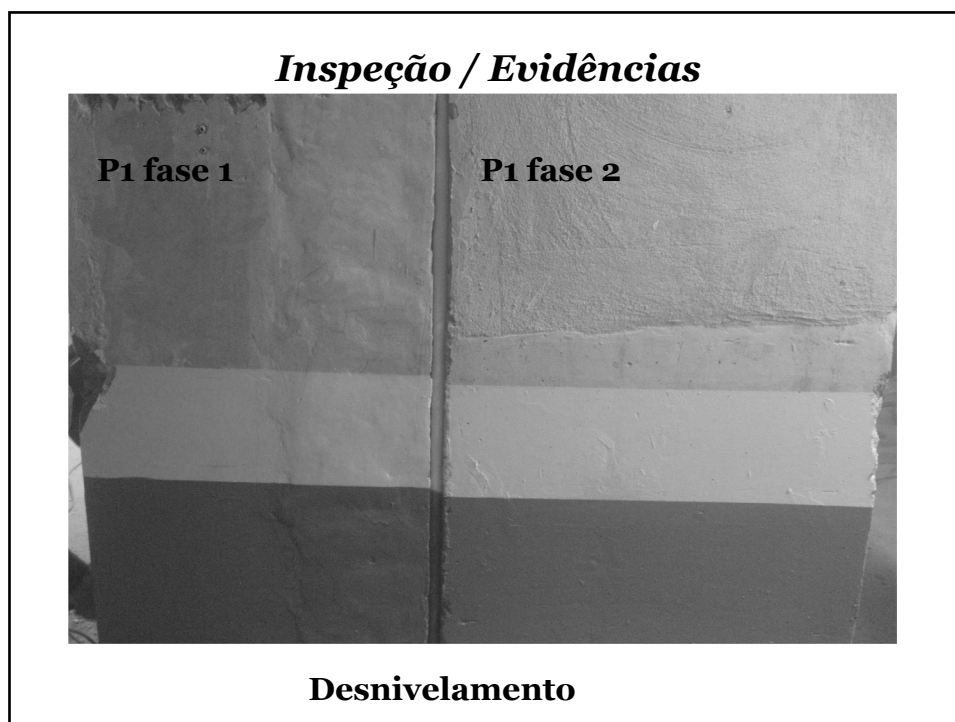

36

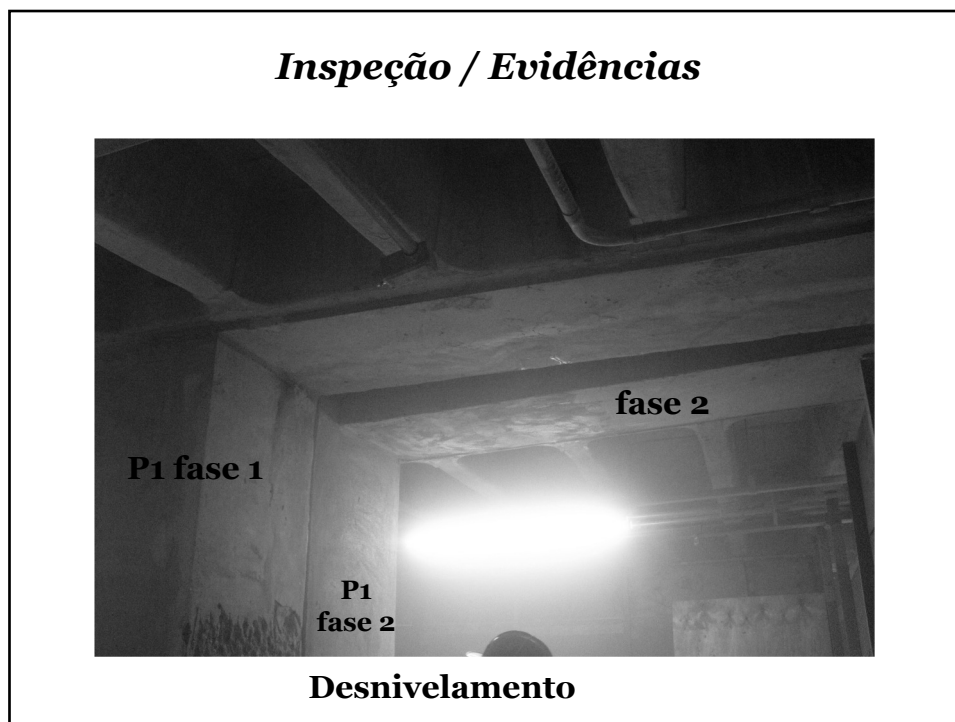

37



38

Inspeção / Evidências



Fissuras em Vigas

39

Inspeção / Evidências



Fissuras em Vigas

40



41

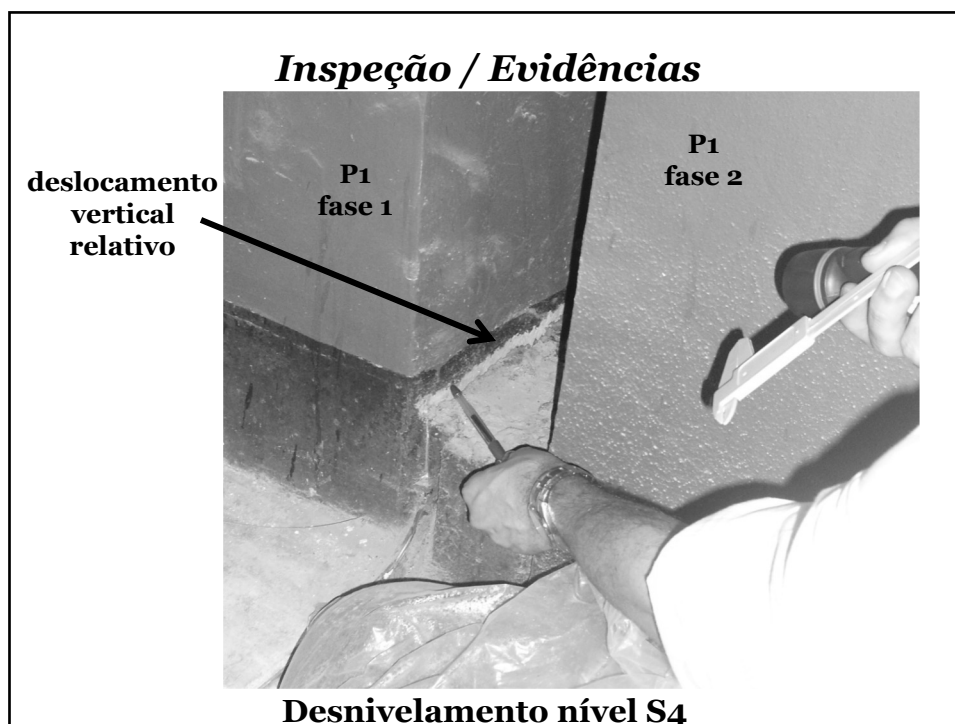

42



43



44

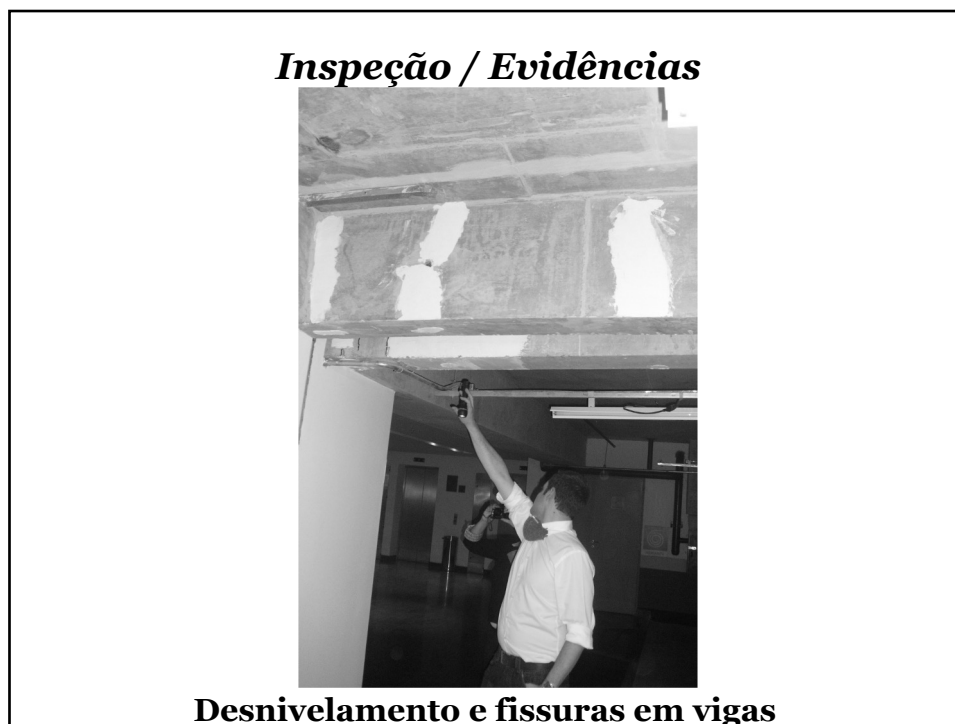

45

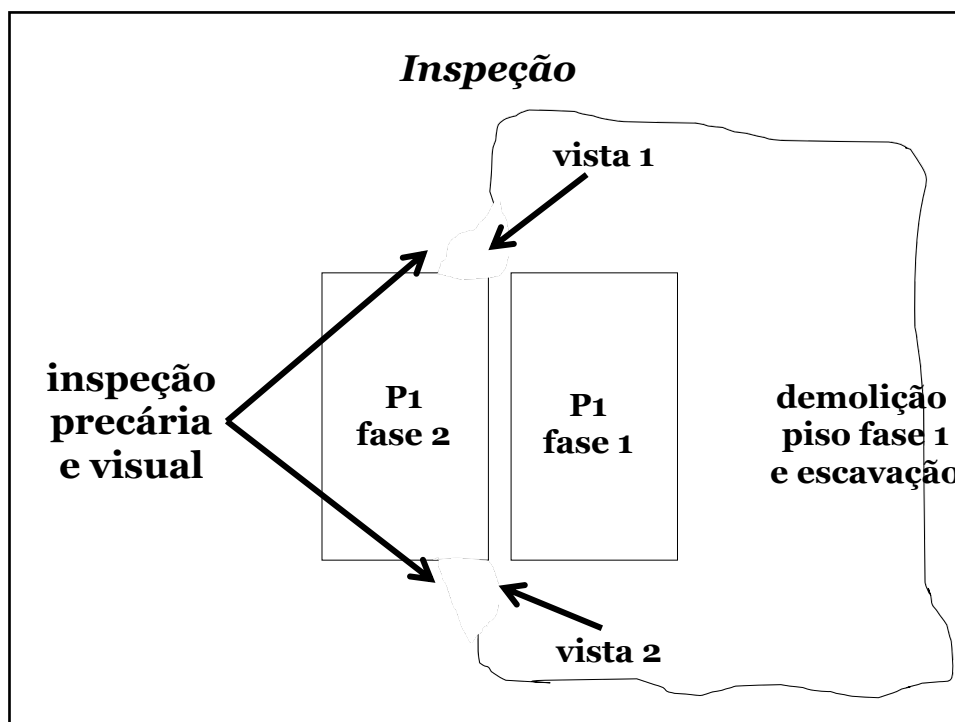

46

Inspeção



Demolição Piso fase 1

47

Inspeção



Escavação Piso fase 1

48



49

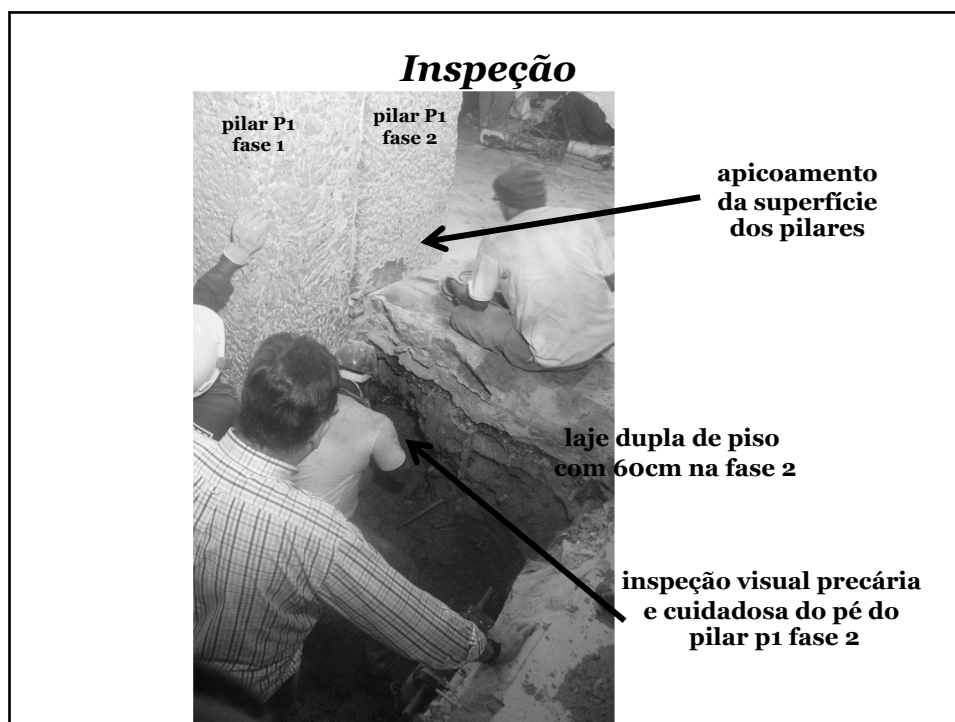

50

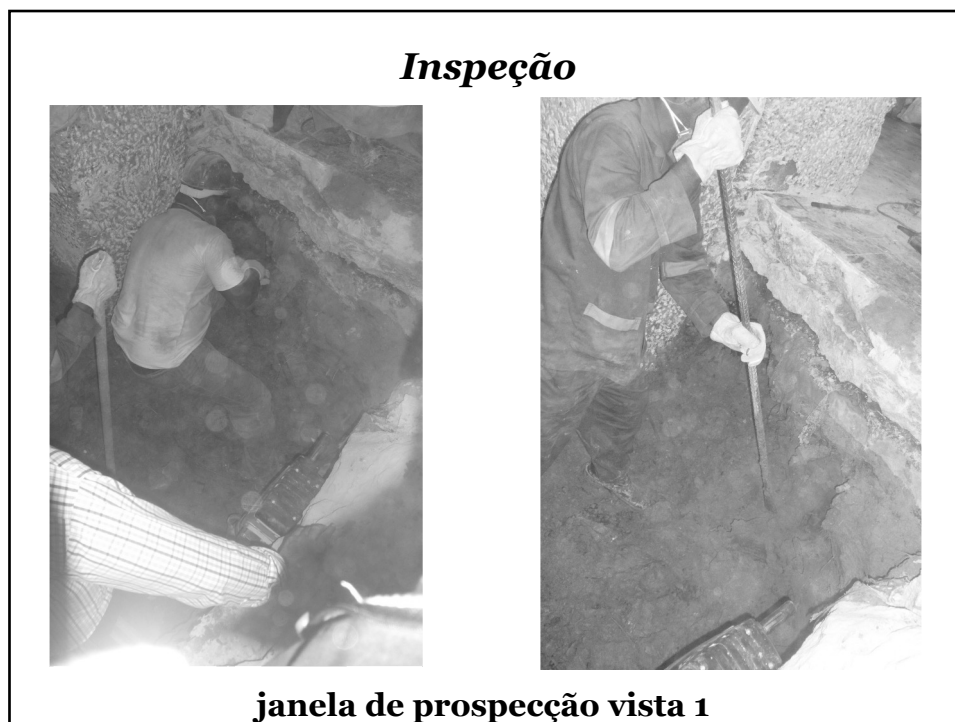

51

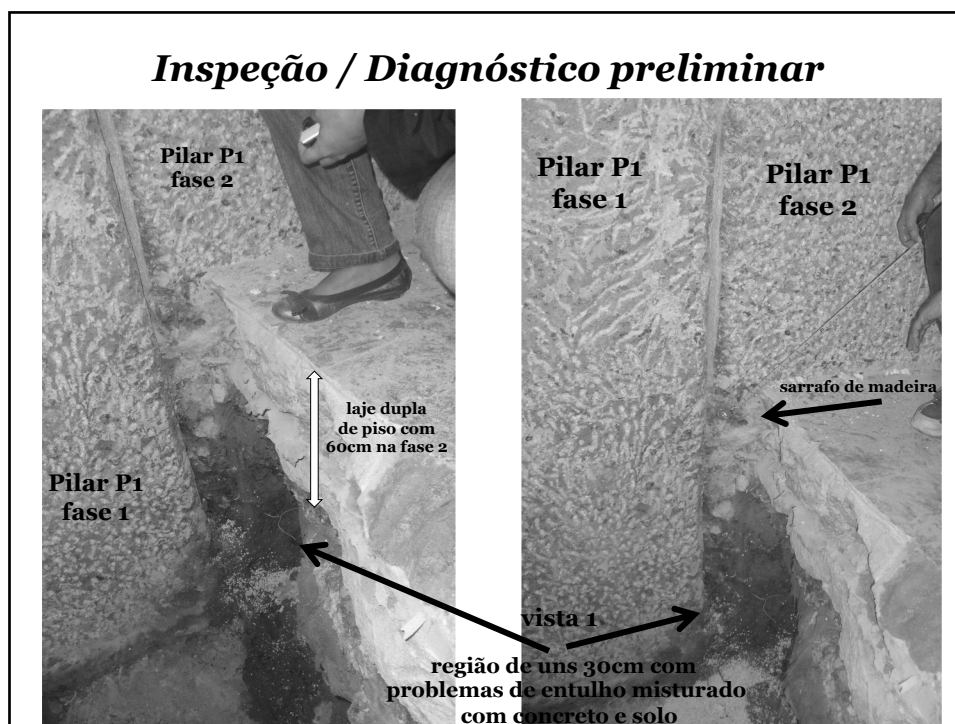

52

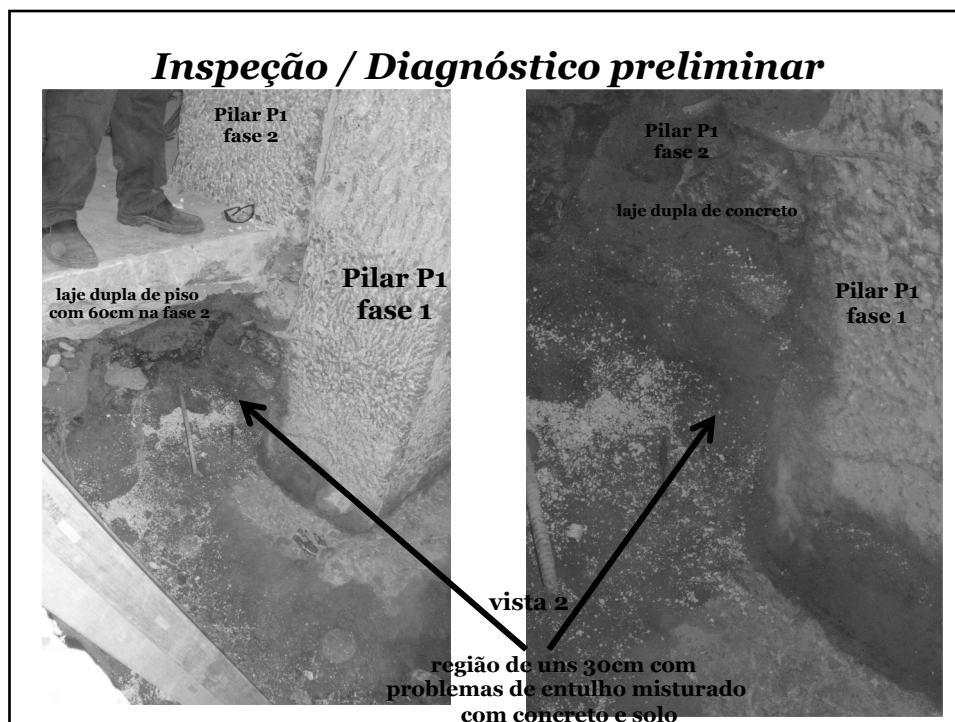

53

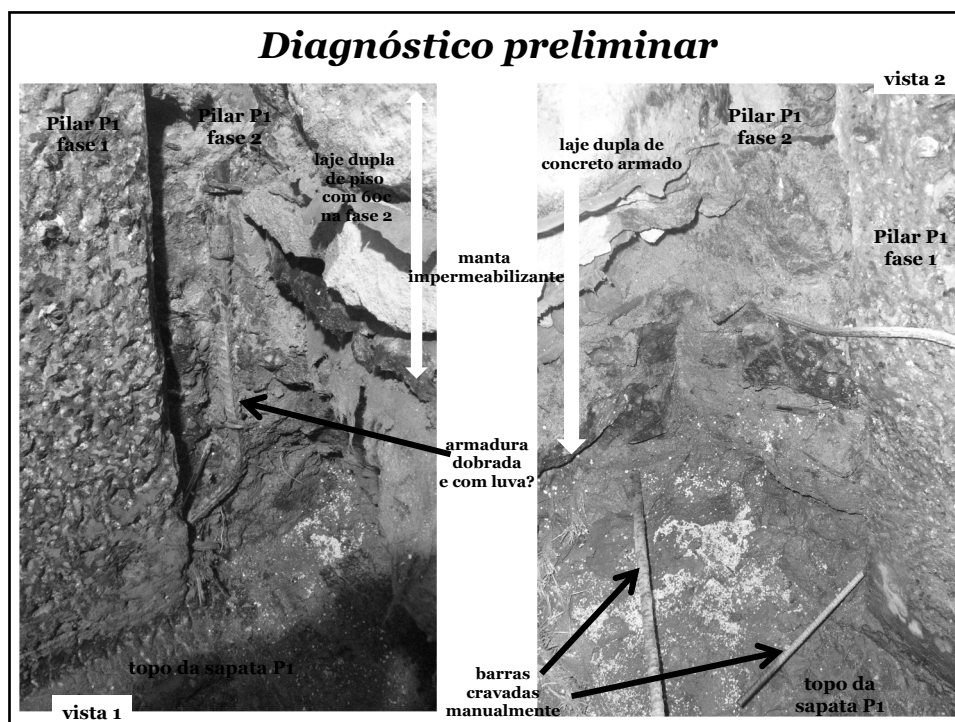

54

Inspeção



Controle contínuo de deslocamento vertical (recalque) dos pilares P1, P1A e P2

55

Inspeção

**nesse momento o grupo
encarregado da observação
por topografia da
movimentação da estrutura
informou que o pilar P1 fase
2 desceu 3mm!!**

56

Inspeção



o encarregado
da observação
do selo
de
gesso
confirmou
rompimento
do gesso

57

Inspeção

**imediatamente os
serviços de
escavação e
prospecção foram
interrompidos**

58

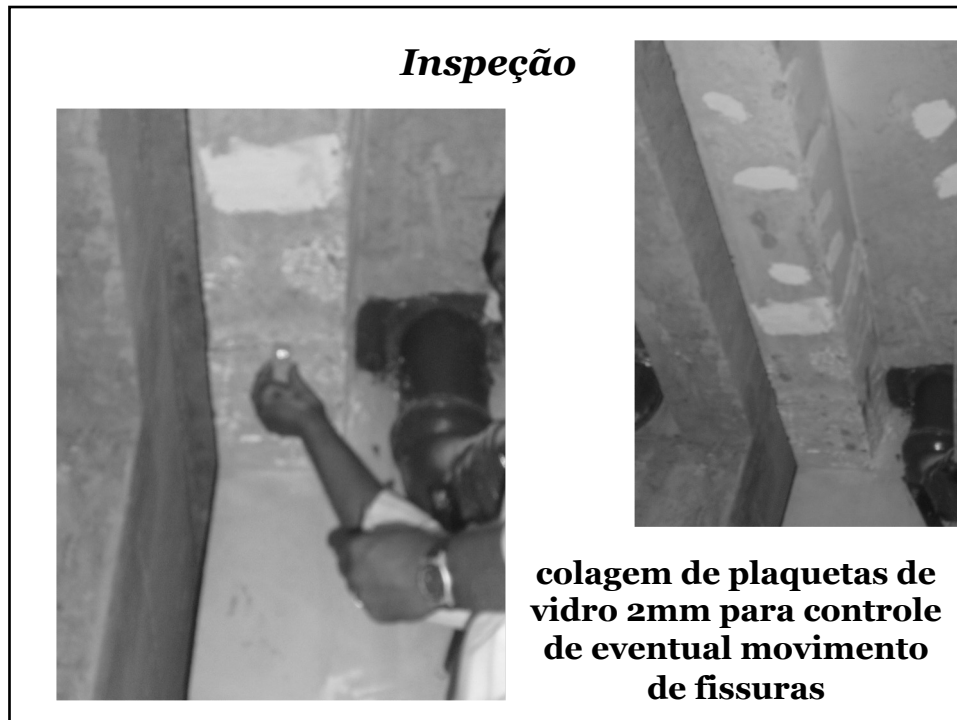

59

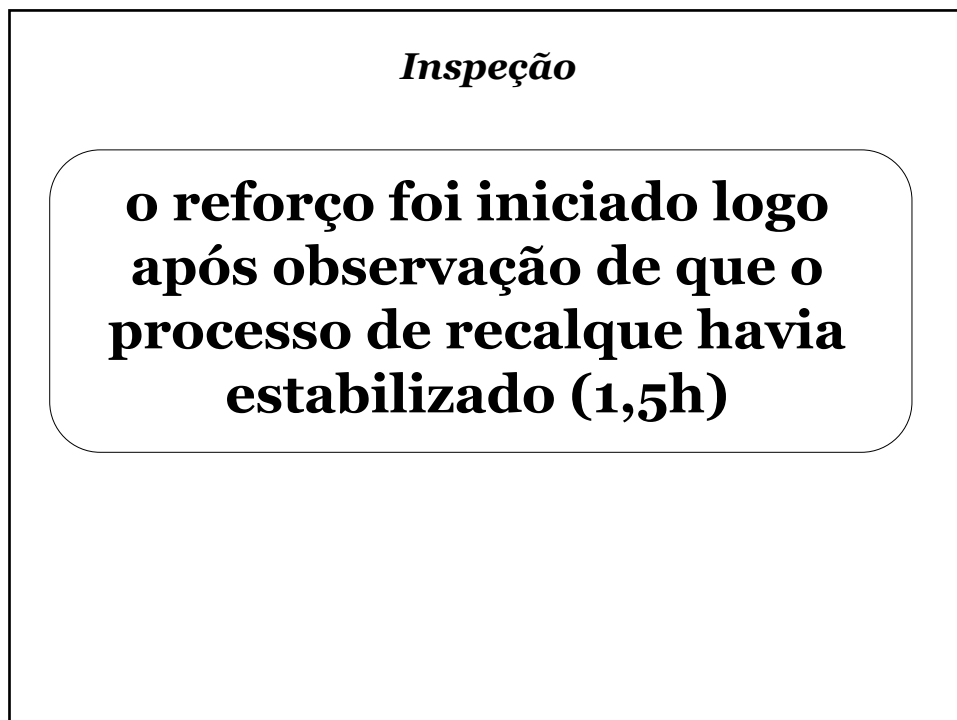

60

Procedimento Padrão para Reforço do Pilar P1 com Problema

1. Inspeção / diagnóstico;
2. Escavação;
3. Preparação do substrato;
4. Montagem da armadura;
5. Preparação da fôrma;
6. Preparação do graute;
7. Concretagem;
8. Desfôrma;
9. Cura.

61

4. Preparação da fôrma



62

5.Preparação do Graute



63

5.Preparação do Graute



64



65

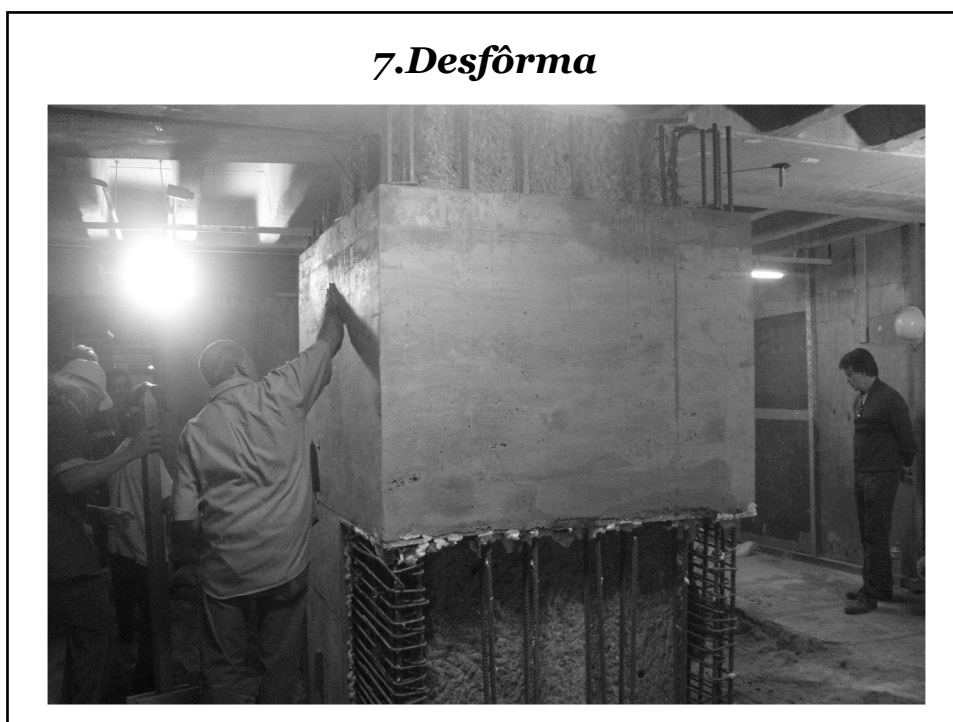

66



67



68



69



70



71



72

Após concretagem piso desceu 4mm



73

Após concretagem piso desceu 4mm



74



75



76



77



78



79

Resistência a Compressão Axial

Pilar	Resistência a compressão axial - MPa				
	24h.	2dias	3dias	7dias	28dias
P4	57,3	59,9	61,2	68,2	73,6
	59,5	62,4	63,7	68,8	73,6
	-	51,3	51,5	54,9	77,1
	-	52,2	55,5	57,6	73,8
Piso	-	54,1	46,4	57,4	75,9
	-	55,2	48,3	56,4	74,3

80

Hipóteses prováveis...

81

Hipóteses prováveis...



82

A origem e os intervenientes



**projetista
estrutural**

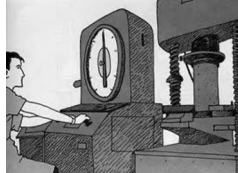

**tecnologista
de concreto**



**fornecedor do
material**



**construtor
(execução)**

***atribuição de responsabilidades
NBR 12655:2006***

83

Edifício Habitacional

**armadura de
pilares
*obra nova***

84



85



86



87

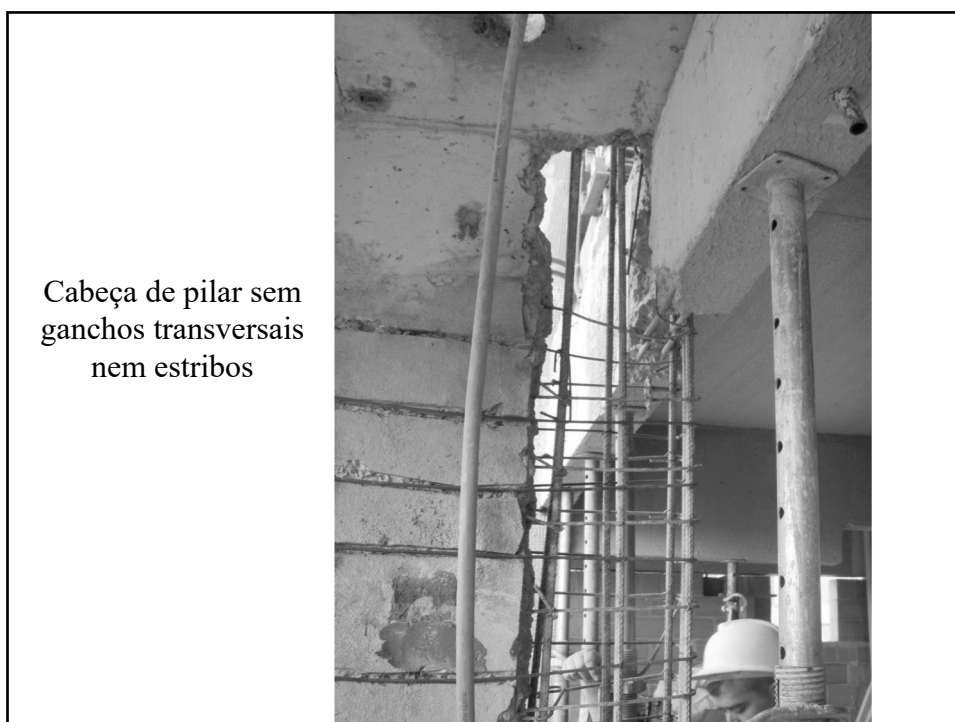

88



89

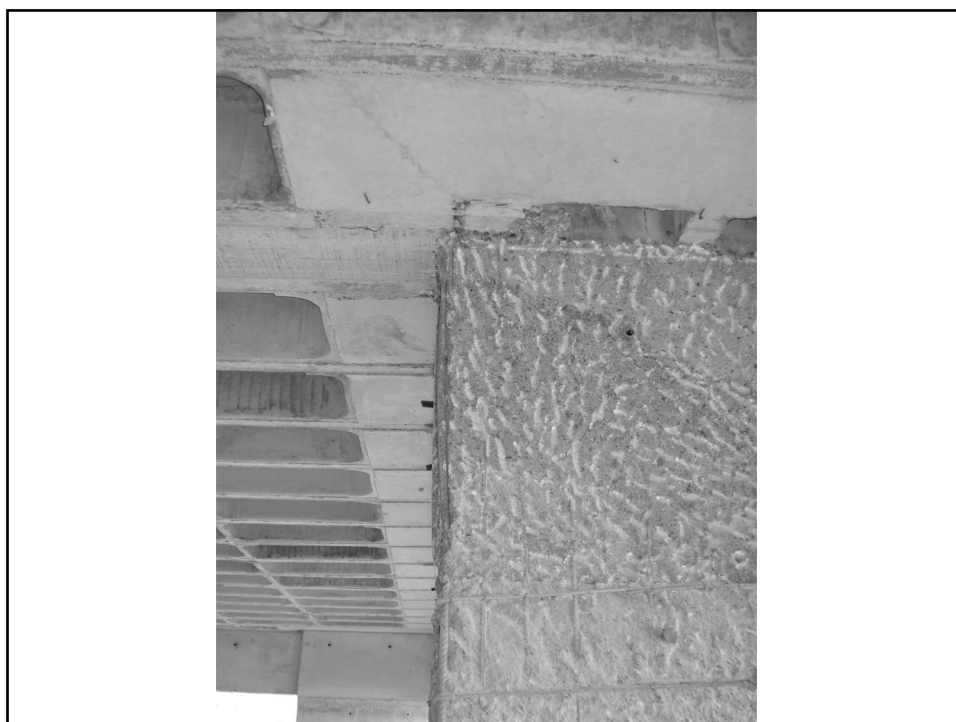

90



91

Qual o papel
do
Construtor?

92

- ✓ Tornar realidade um Projeto
- ✓ Compatibilizar sonhos (projetos)
- ✓ Realizar expectativas
- ✓ Liderar operários (dar o exemplo, saber fazer, dar importância ao que eles fazem)
- ✓ Não é gerenciar, nem projetar!

93

terceirizar um
serviço ≠
terceirizar
responsabilidade

94



95



96

Solução adotada:

recompor a armadura transversal acrescentando estribos e ganchos passantes ao reforço, conforme critério da NBR6118:2007 – com espaçamento máx. de $20.\varnothing$

97

Detalhe do reforço

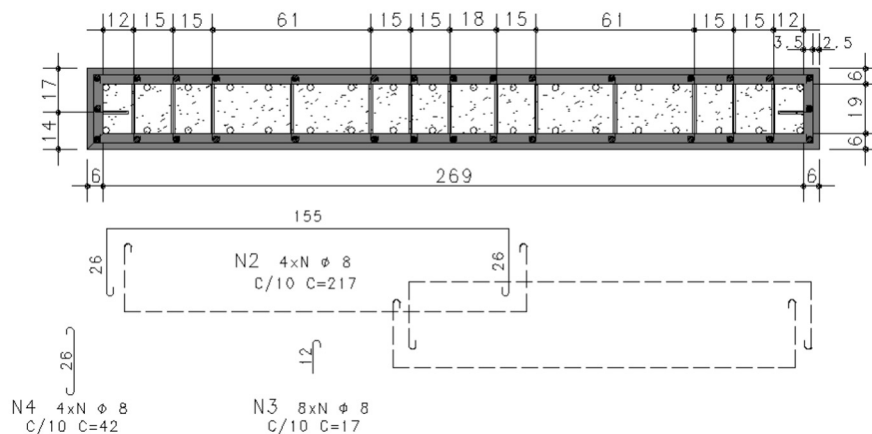

98

Detalhe do reforço

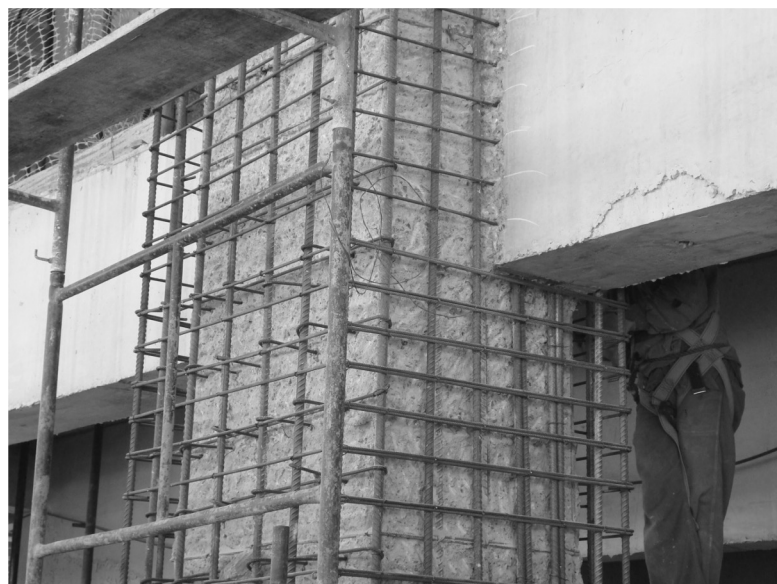

99

**outro caso
desastroso!**

100

LEVANTAMENTO DE CAMPO DAS ARMADURAS PILARES				
PILAR	DIMENSÃO PILAR NO SUBSOLO (cm)	FERRO LONGITUDINAL EXECUTADO (QUANT./mm)	FERRO LONGITUDINAL PROJETADO (QUANT./mm)	diferença
01	(20 x 100)	10 Ø 12.5	14 Ø 10.0	+12 %
02	(30 x 50)	22 Ø 12.5	16 Ø 16.0	- 16 %
03	(20 x 100)	48 Ø 16.0	50 Ø 16.0	- 4 %
04	(20 x 100)	24 Ø 16.0	36 Ø 16.0	- 33 %
05	(30 x 50)	24 Ø 12.5	18 Ø 16.0	- 19 %
06	(20 x 100)	10 Ø 12.5	14 Ø 10.0	+12 %
07	(20 x 70)	10 Ø 10.0	10 Ø 10.0	-----
08	(20 x 70)	08 Ø 12.5	08 Ø 10.0	+ 56 %
09	(25 x 80)	28 Ø 16.0	20 Ø 20.0	- 10 %

101

Registrado em 06 de abril de 2011. Livro: 010/ENG.				
				diferença
10	(20 x 100)	34 Ø 12.5	34 Ø 16.0	- 39 %
11	(25 x 125)	18 Ø 12.5	28 Ø 10.0	+5 %
12	(25 x 178)	38 Ø 10.0	38 Ø 10.0	-----
13	(25 x 178)	16 Ø 16.0	38 Ø 10.0	+8 %
14	(25 x 125)	18 Ø 12.5	28 Ø 10.0	+0,5 %
15	(20 x 218)	34 Ø 10.0	34 Ø 10.0	-----
16	(20 x 218)	Ø 10.0	34 Ø 10.0	-----
17	(20 x 70)	10 Ø 10.0	10 Ø 10.0	-----
18	(30 x 70)	18 Ø 12.5	28 Ø 10.0	+0,5 %
19	(30 x 70)	08 Ø 16.0	20 Ø 10.0	+2 %
20	(20 x 70)	08 Ø 12.5	08 Ø 10.0	+56 %
21	(20 x 70)	12 Ø 12.5	30 Ø 10.0	- 37 %
22	("25" x 100)	42 Ø 16.0	30 Ø 20.0	- 10 %
23	("25" x "208")	34 Ø 12.5	76 Ø 10.0	- 30 %
24	("25" x 100)	42 Ø 16.0	34 Ø 20.0	- 21 %
25	(20 x 70)	08 Ø 12.5	16 Ø 10.0	- 22 %

Obs: Foi constatado que todos os estribos possuíam bitolas de 4.2mm com espaçamento entre eles de 15cm exceto o pilar P15 que possui estribos de 6.3mm e espaçamento igual aos demais.

102



103

Edifício Real Class



Belém do Pará
34 pavimentos
105m 20.01.2011 35MPa

104

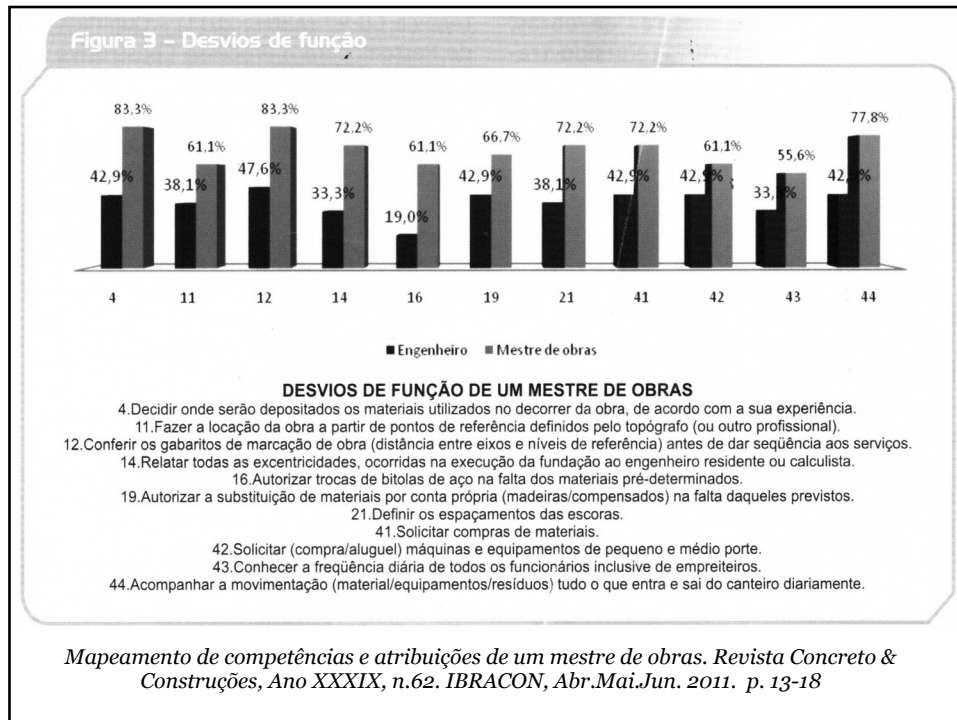

105

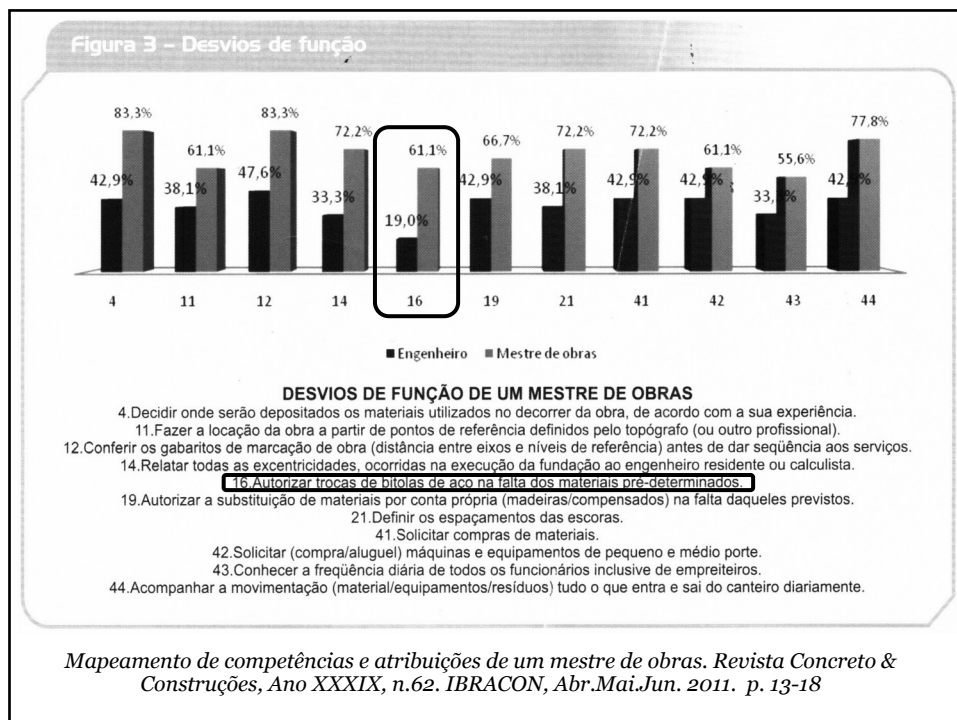

106

Edifício Habitacional

concretagem de pilares *obra nova*

107



108



109



110

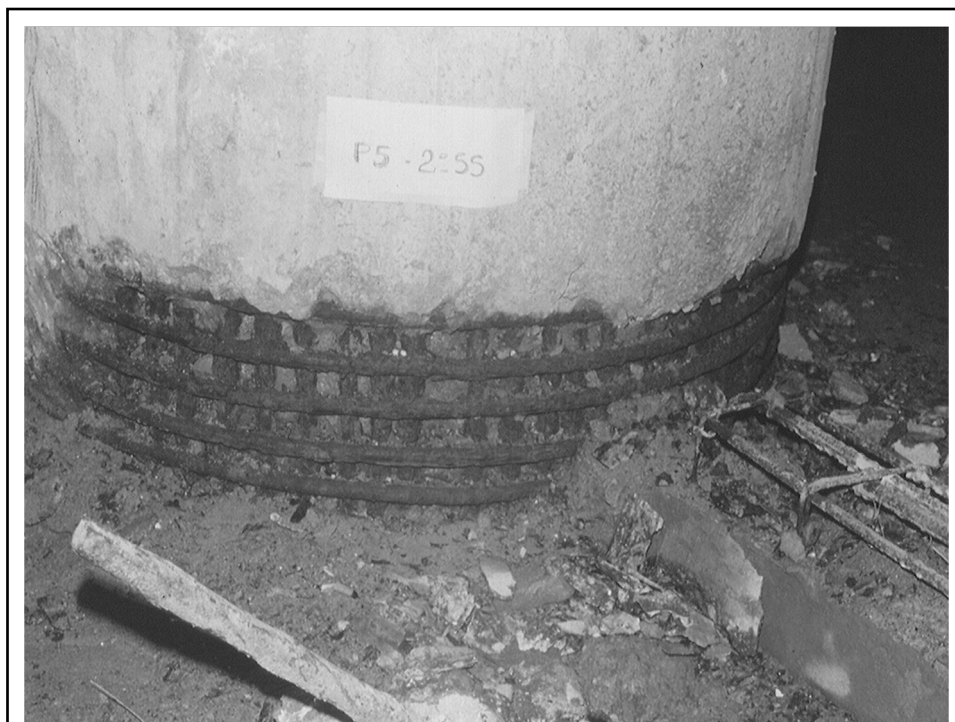

111



112

CONSTRUTOR

precisa ter consciência
de que a consequência
de seus atos pode levar
anos para aparecer!

113

Edifício Areia Branca

Recife, Pernambuco
14 de outubro de 2004
quinta-feira às 20:30h
1977 → 1979
25 anos
12 andares + térreo + 1 garagem

114



115



116



117



118



119



120

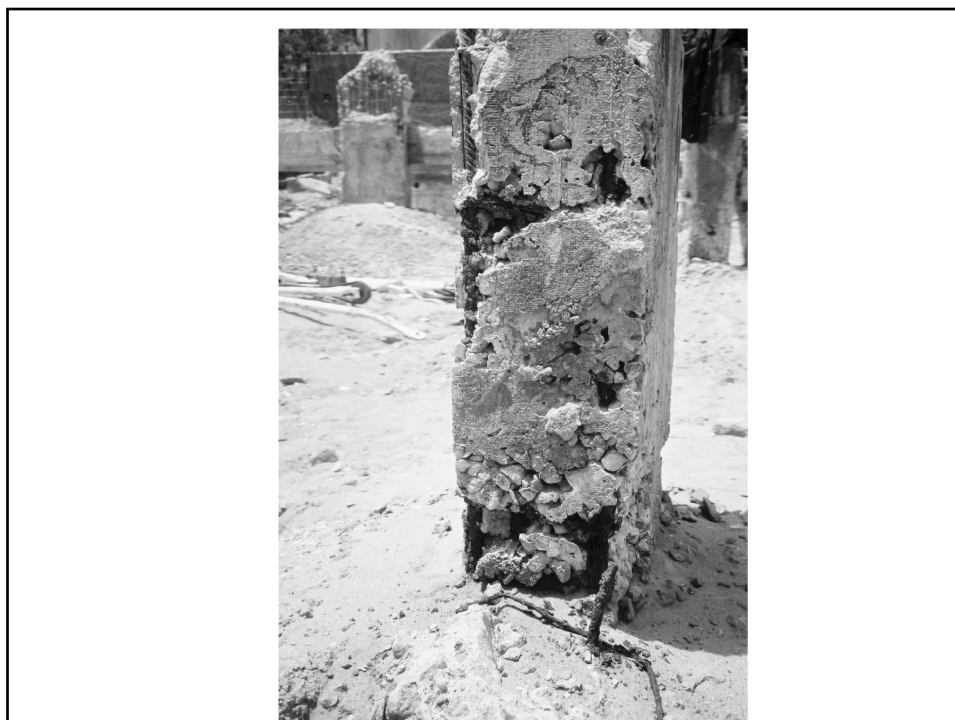

121

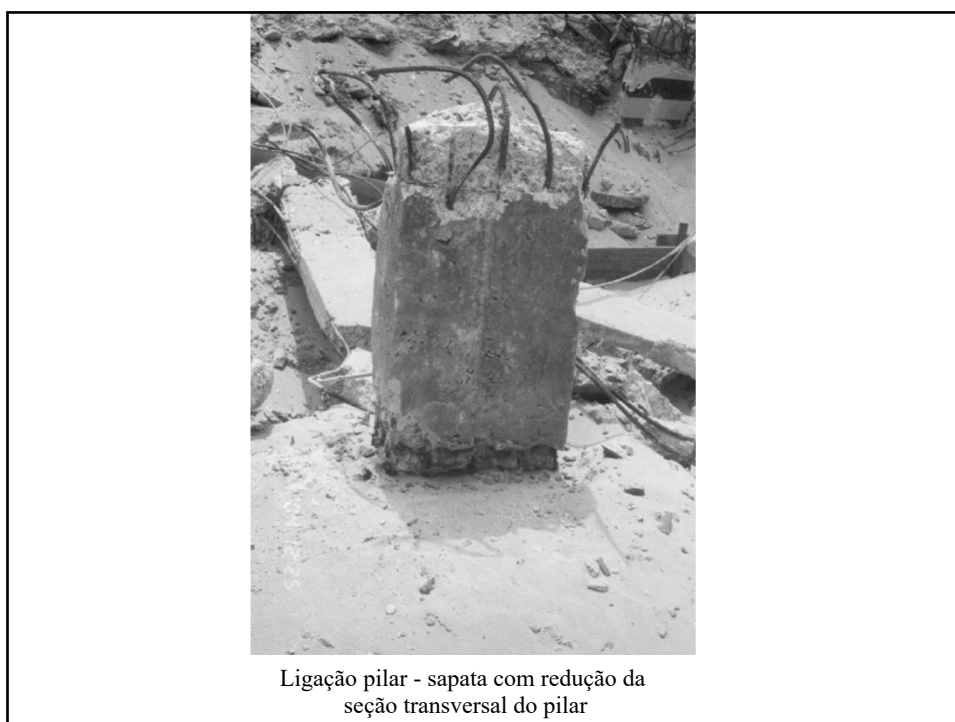

Ligação pilar - sapata com redução da seção transversal do pilar

122



123



124

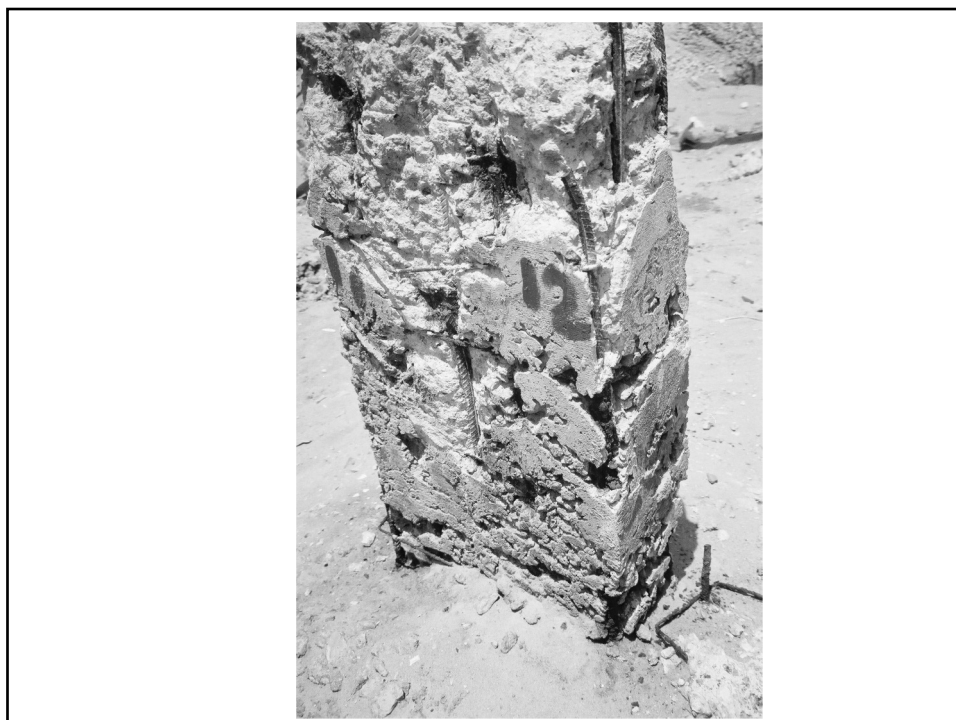

125

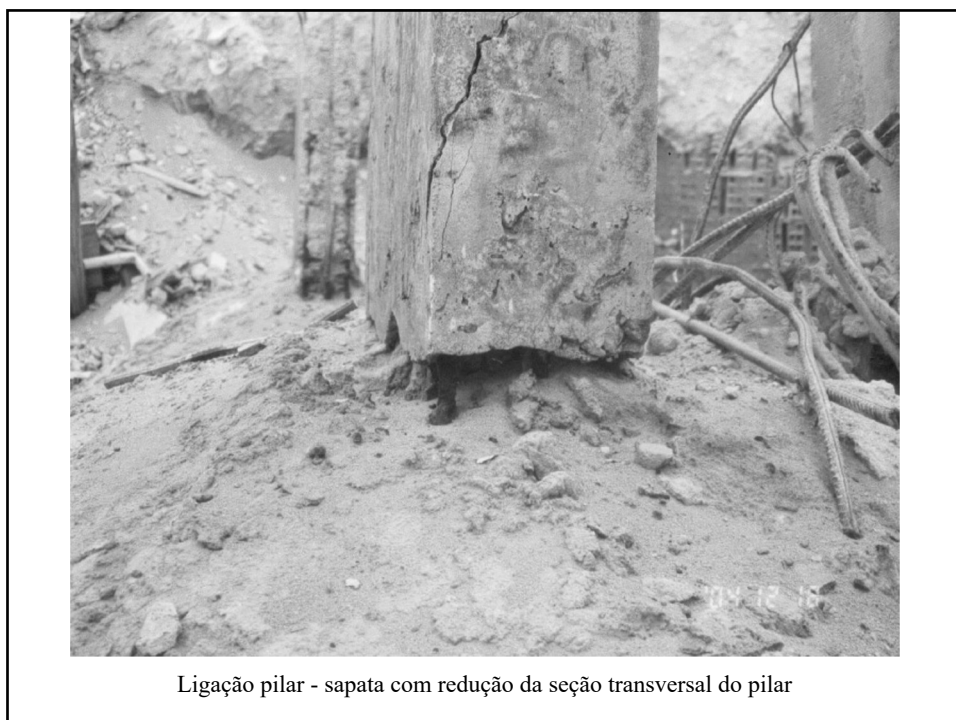

126



127

Edifício Solar da Piedade
vizinho ao
Areia Branca
Recife, Pernambuco
novembro de 2004
inspeção impede colapso

128



Edifício Solar da Piedade, Boa Viagem, Recife PE

129



130

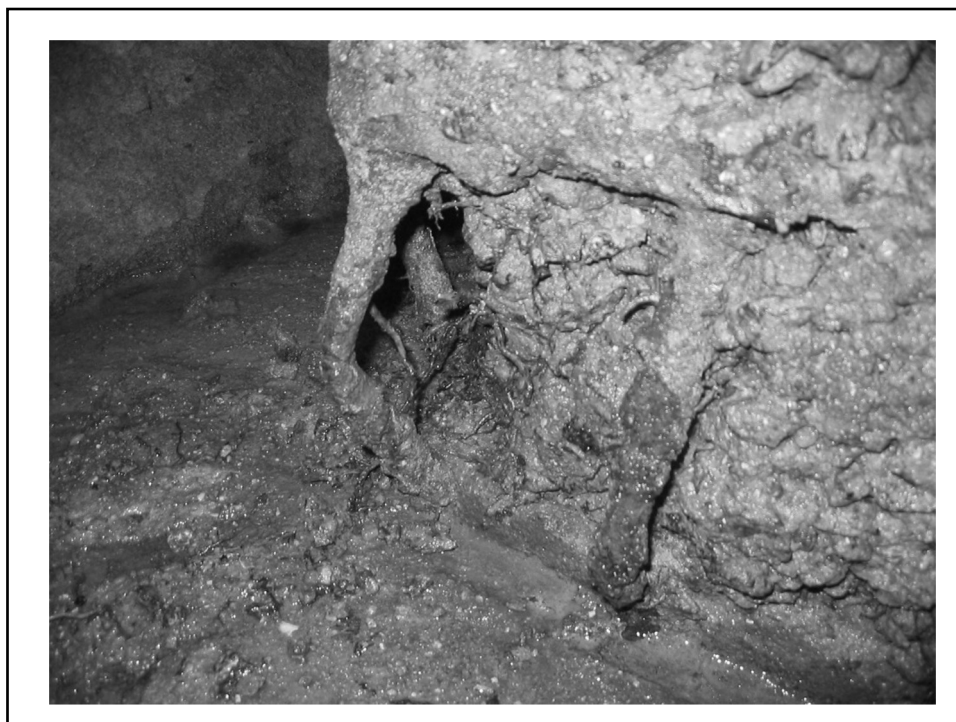

131



132



133

CONSTRUTOR

precisa ter consciência
de que as consequências
de seus atos podem ser
desastrosas e onerosas!

134

Edifício de
apartamentos
Jaguaré, São Paulo
58 anos
Pilar rompido

135



136



137



138

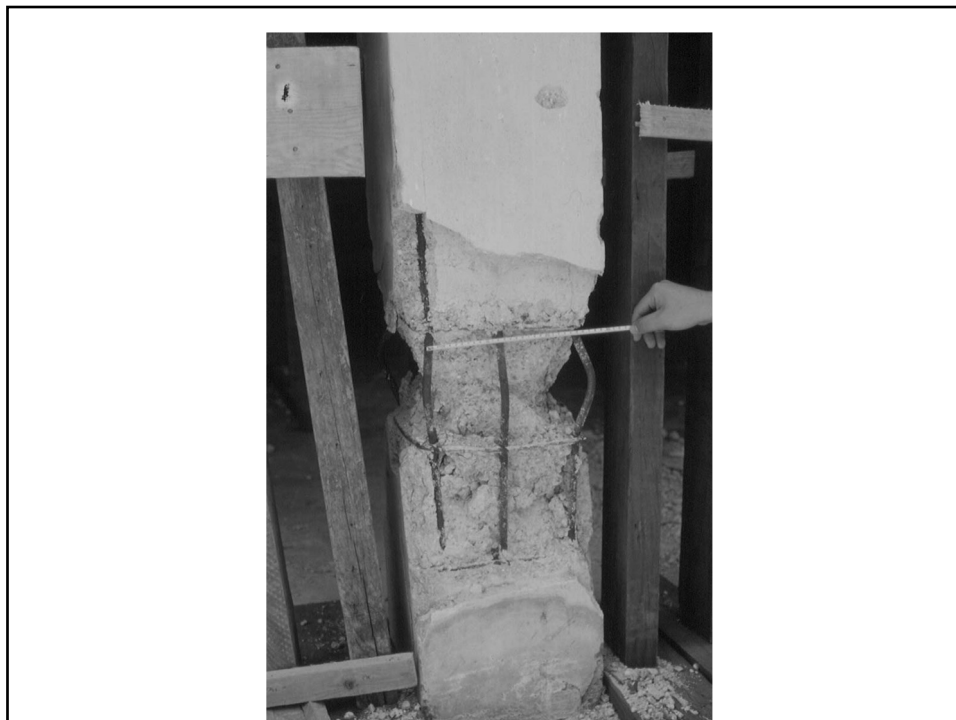

139



140

Shopping Center

bicheiras e ninhos de
concretagem em vigas

141

Bicheiras nas Vigas (falta de adensamento)



142

Bicheiras nas Vigas (falta de adensamento)

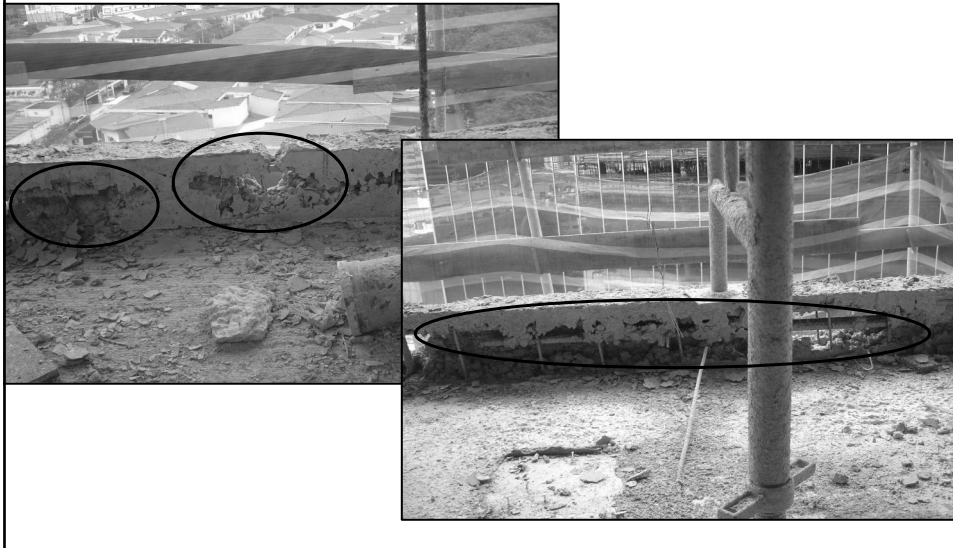

143

Bicheiras nas Vigas (falta de adensamento)

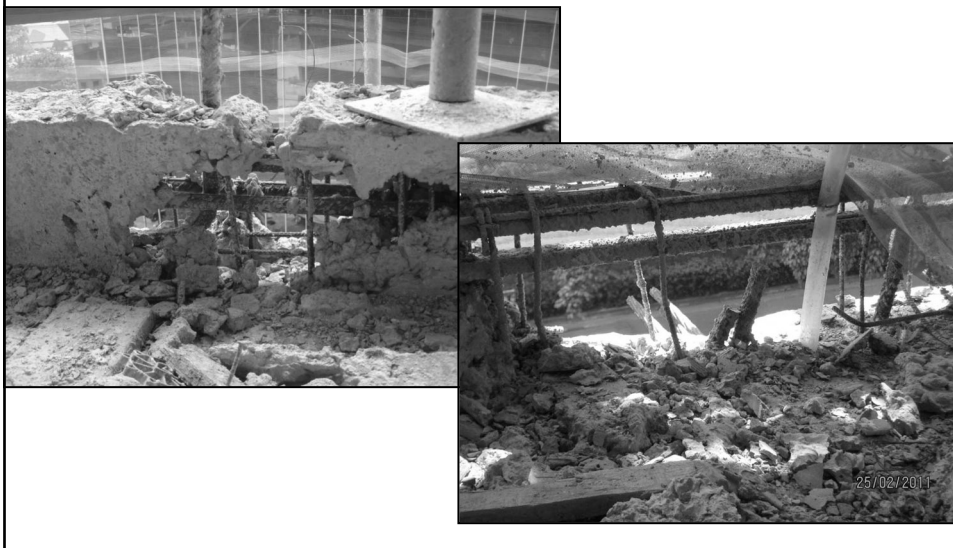

144



145

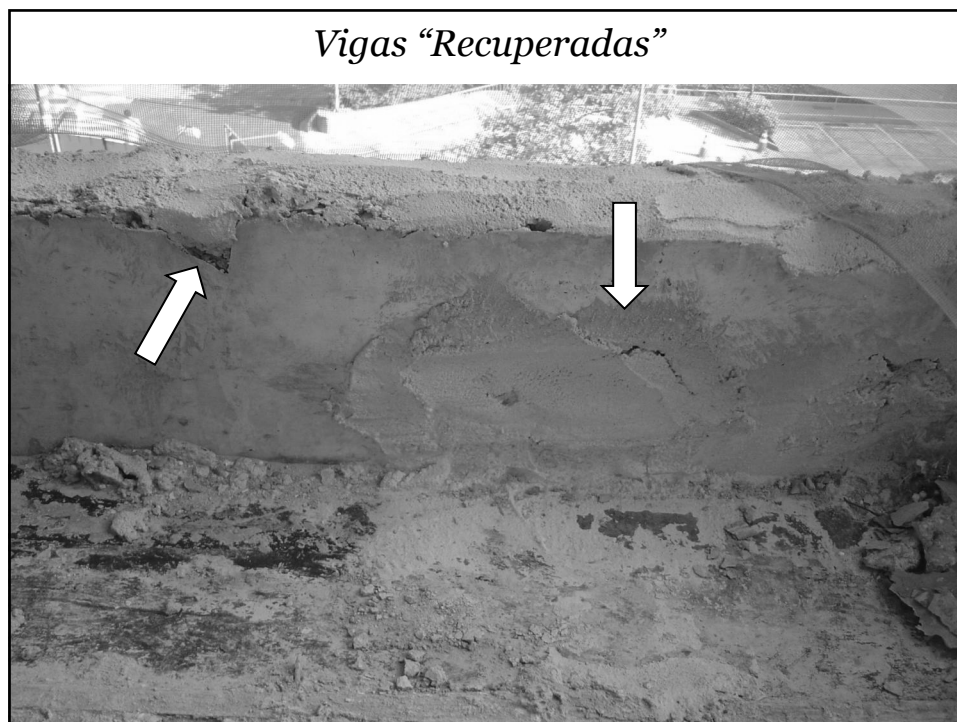

146

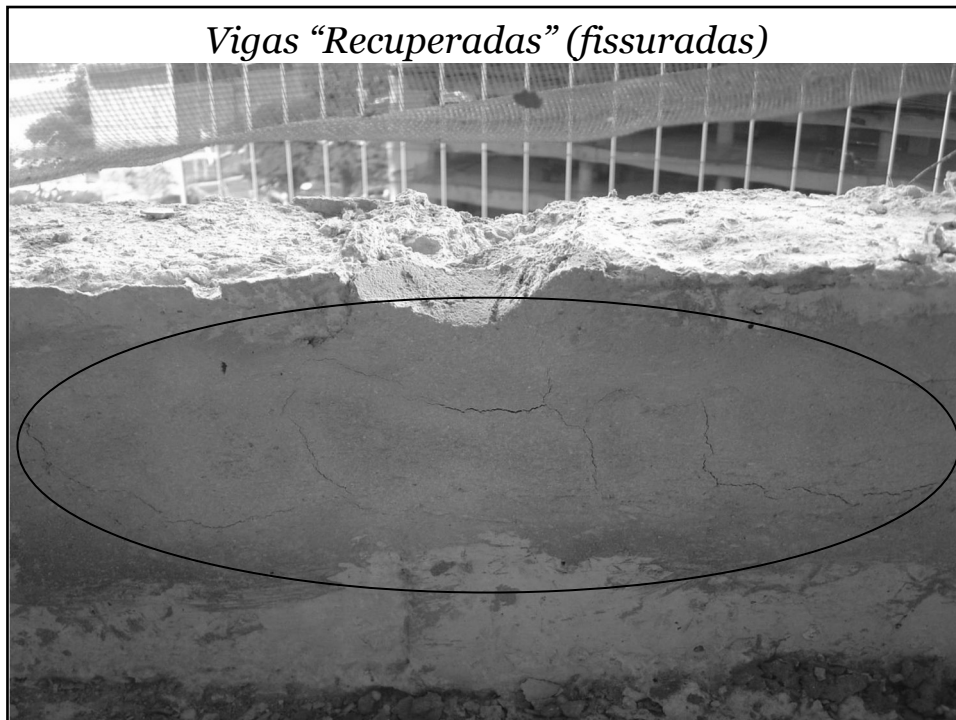

147

Edifício Emblemático

Alphaville, São Paulo

50MPa

35 andares

Comercial

ninho de concretagem

148



149



150



151



152



153



154



155



156



157

**alinhamento
de pilares,
excentricidade**

158

Pilar executado com um tramo deslocado dos demais em 8cm:

8cm
↙

159



160



161



162

Solução: Demolição do excedente e aumento da seção do lado oposto para trazer o pilar a sua posição original de projeto.

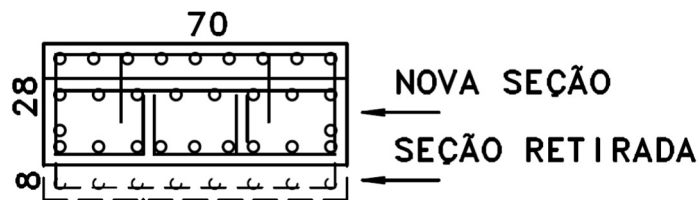

163

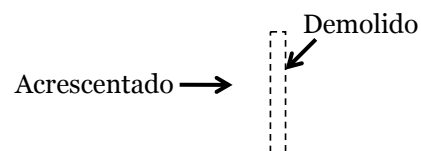

164



165

Compatibilidade de Projetos

166

Incompatibilidade de Projetos (estrutura x caixilhos)

- Não foi analisado em conjunto o projeto de caixilho e o projeto da estrutura;
- As vigas invertidas foram quebradas para inserir os inserts de fixação da pele de vidro na fachada;

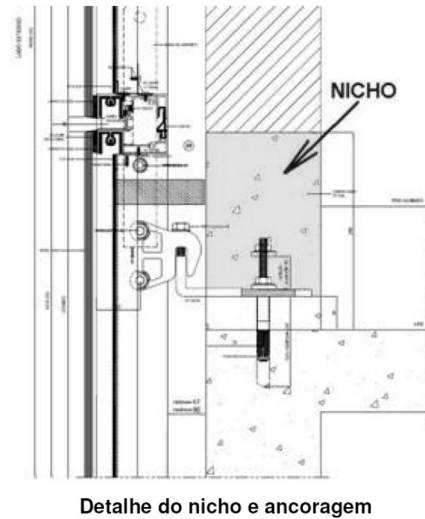

Projeto do Caixilho



167

Projeto dos Inserts para Fixação da Pele de Vidro

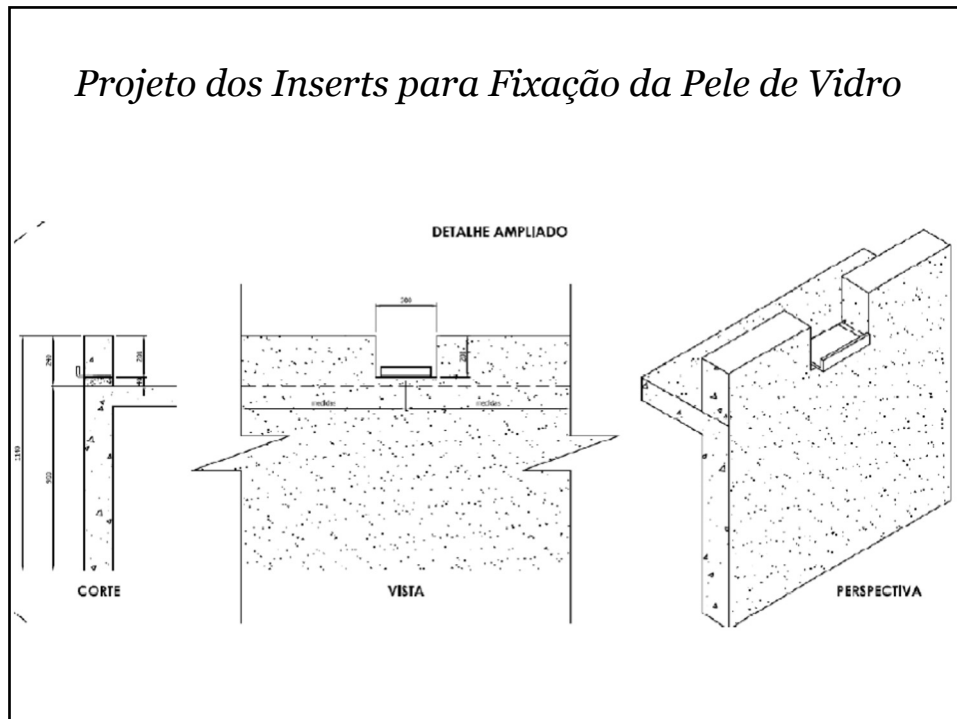

168

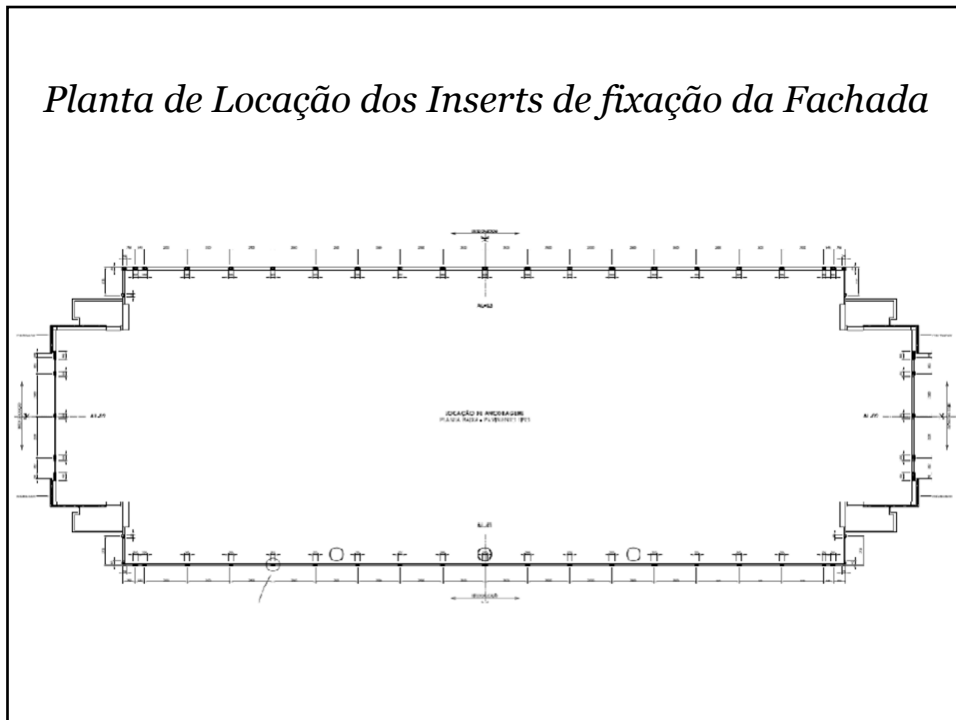

169

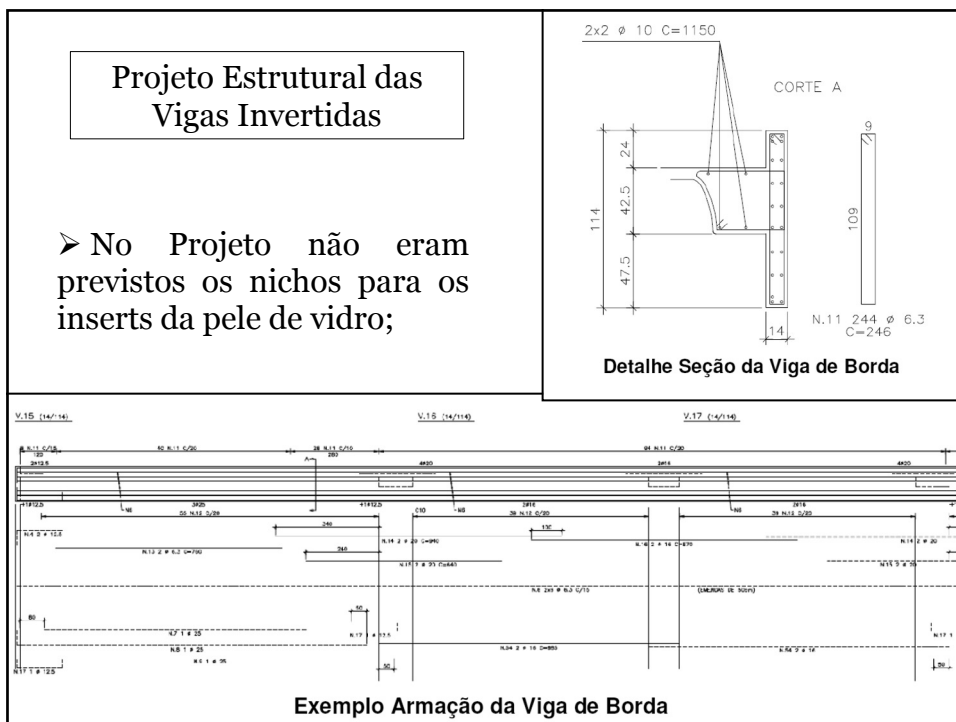

170

Vigas sendo Demolidas e Cortadas suas Armaduras sem Conhecimento do Projetista



171

Vigas sendo Demolidas e Cortadas suas Armaduras sem Consentimento do Projetista



172



173



174

Recomposição com Graute e Sacos de Papel Vazios

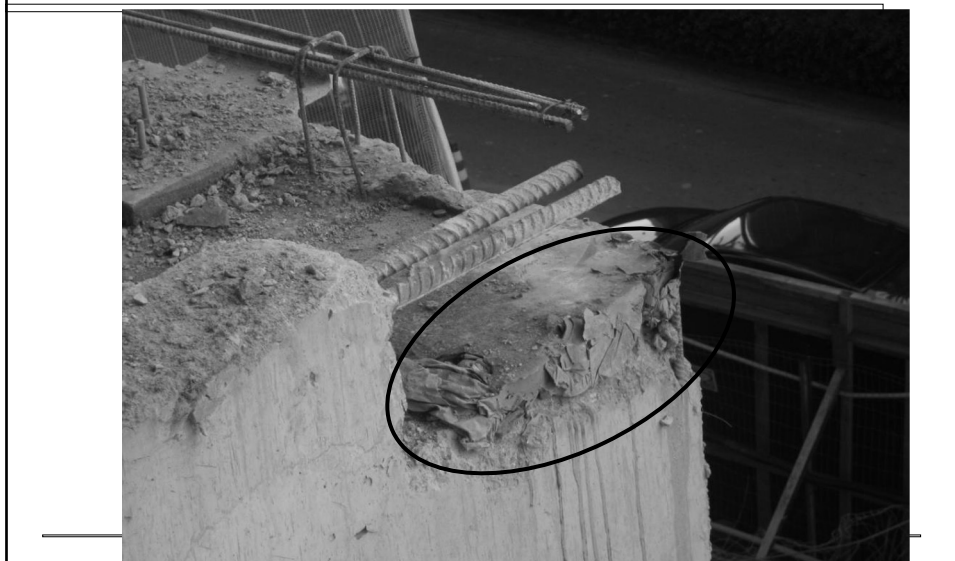

175

Projeto de Recomposição da Armadura

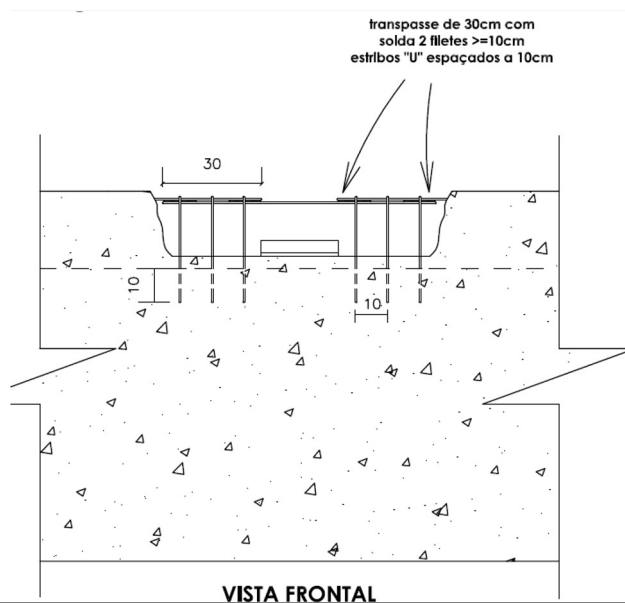

176

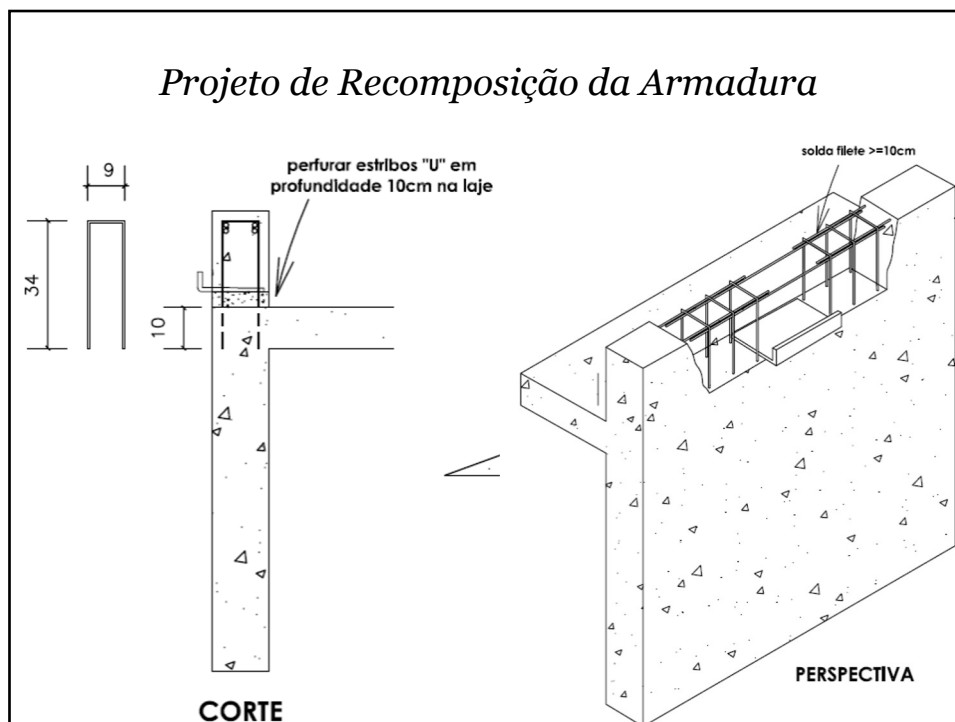

177



178

Recomposição das Armaduras Cortadas



179

CONSTRUTOR

Não entendeu → PERGUNTA

Não achou o detalhe → COBRA

Deve estudar os projetos e
antecipar-se aos problemas!

180

Caso dos capitéis com cota incorreta



181

Croqui da viga com trecho em balanço

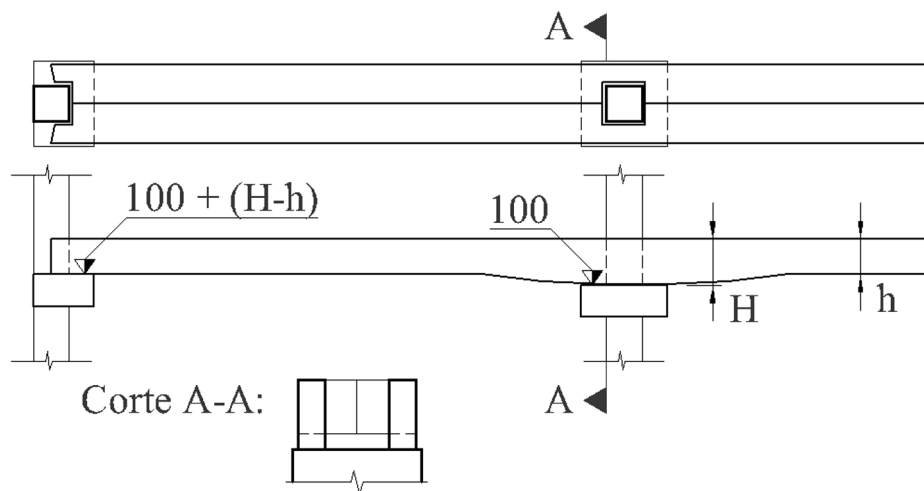

182

Situação dos consoles em nível

⇒ Vigas fora de nível

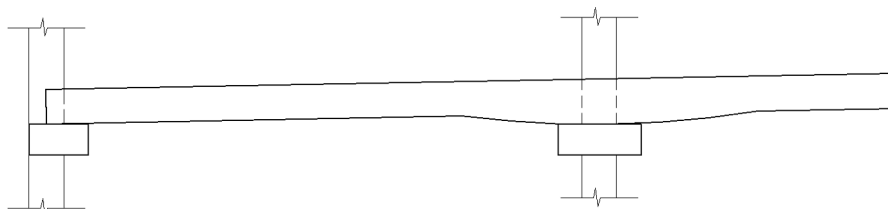

183

Macaqueamento da viga e corte parcial do console

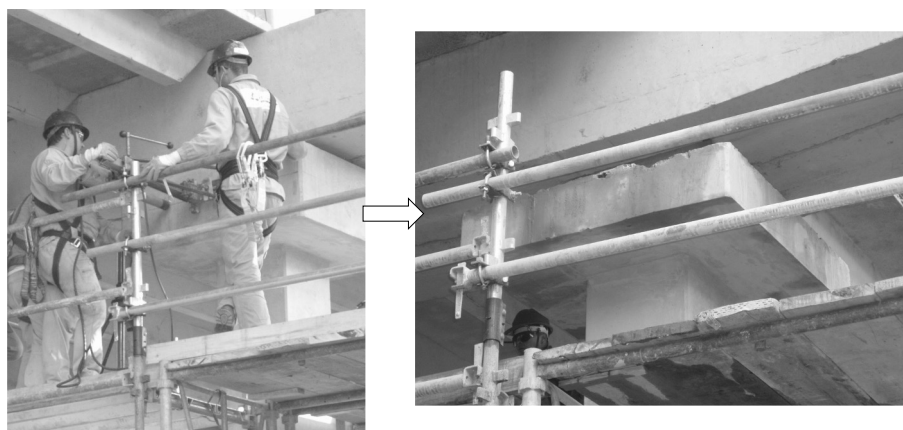

184

Apicoamento superfície do console



185

Armadura adicional do console fôrmas + grauteamento



186

Custos

Segundo o Engenheiro da Construtora o custo direto da correção desse problema foi de 250 mil reais e atraso estimado de 10 dias, graças a uma manobra de remanejamento das equipes de montagem para outros setores da obra.

187

Lições Aprendidas

1. É melhor aprender com os erros dos outros;
2. Sem conhecimento não há evolução;
3. Vale a pena desenvolver o prazer por aprender;
4. Sempre é bom pensar holísticamente.

188

Qual a MISSÃO do Construtor?

189



190



191

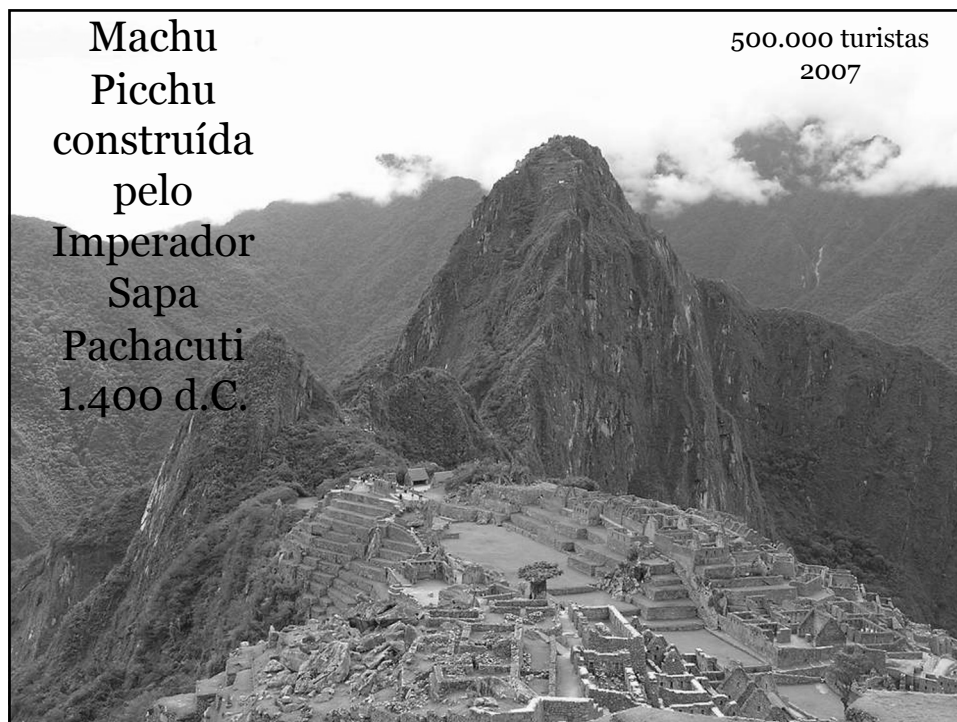

192



193



194

O CONCEITO DE CONSTRUIR COM DURABILIDADE EXISTE NAS OBRAS DESDE A ANTIGUIDADE

razão áurea $C/L = 1,618$ número phi (Phidias)

Arquitetos Ictinos de Mileto e Calícrates (*escultor Fídias*)



Pártenon, 440 aC
“século de Péricles”

195

Panteão de Roma



196



197

Cúpula do Panteão de Roma
Século II dC → Diâmetro de 44m



198

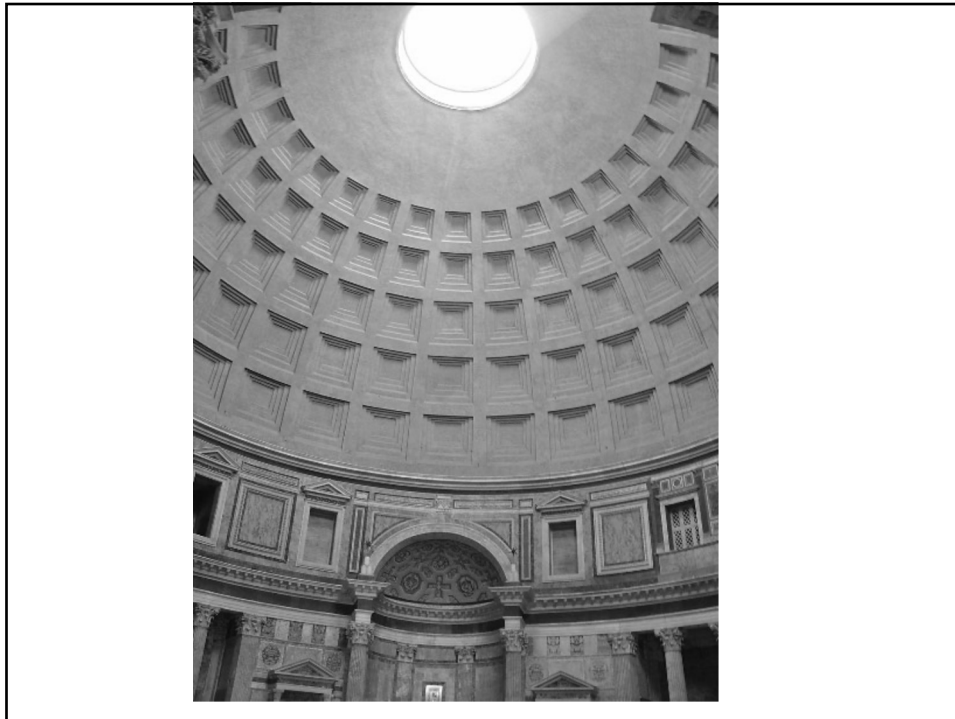

199

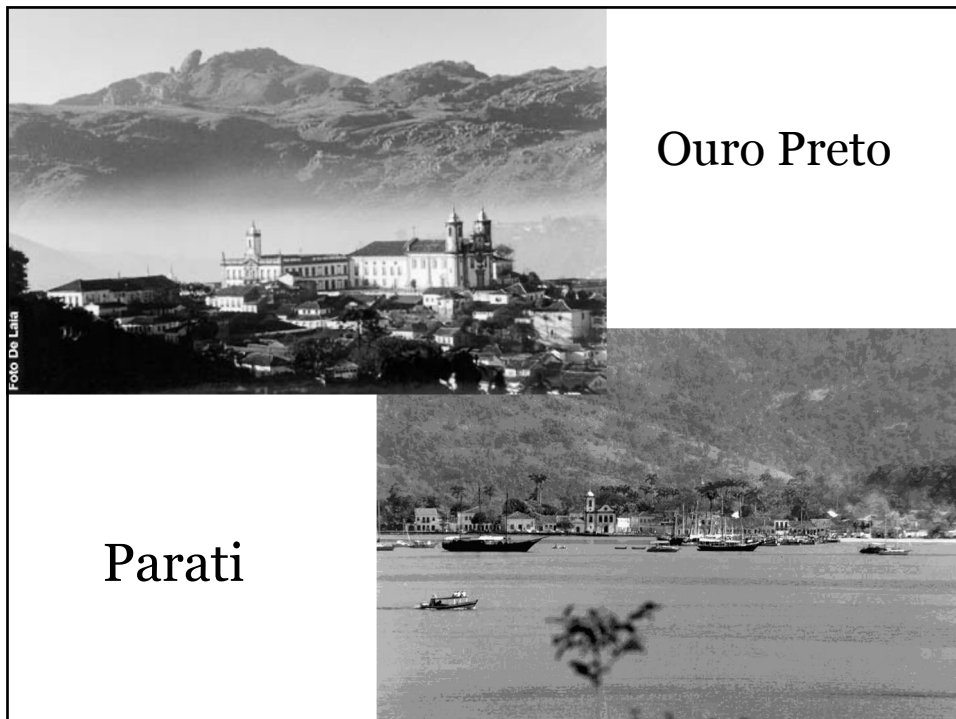

200

Catedral de Notre Dame



1163-1330

Abóbada da nave central → 35 m de altura

201



202

Qual a MISSÃO do Construtor?

- ✓ Sem dúvida a mais nobre
- ✓ Sem dúvida a mais importante
- ✓ Sem dúvida a mais difícil
- ✓ Sem dúvida a mais cara
- ✓ Sem dúvida a de maior responsabilidade

203

Corte longitudinal

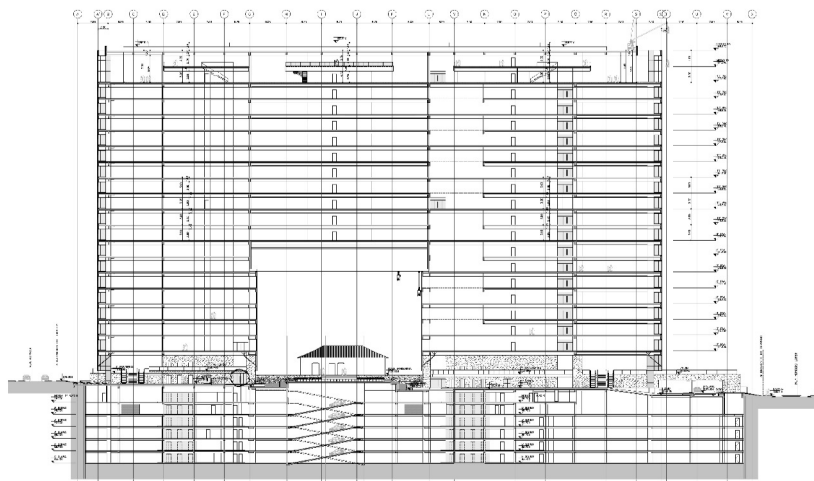

204



205



206

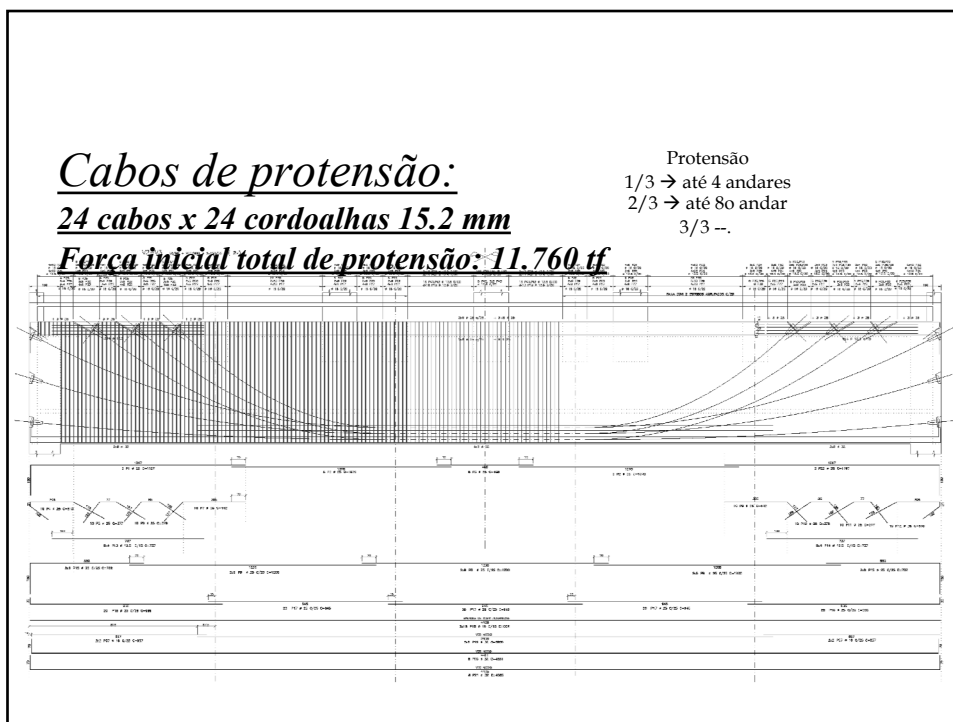

207



208



209

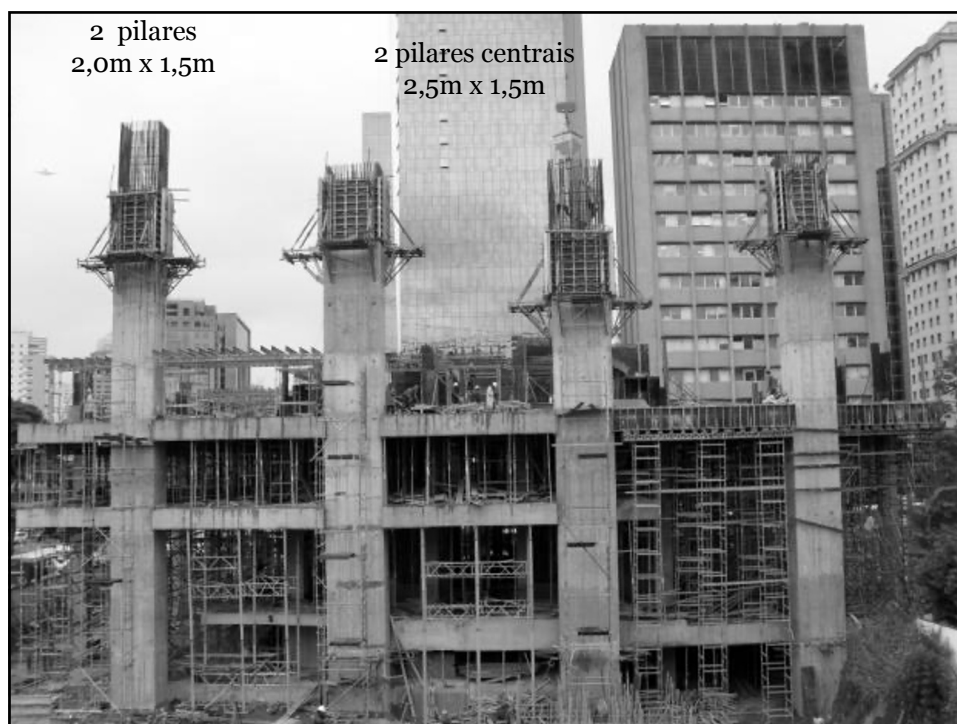

210

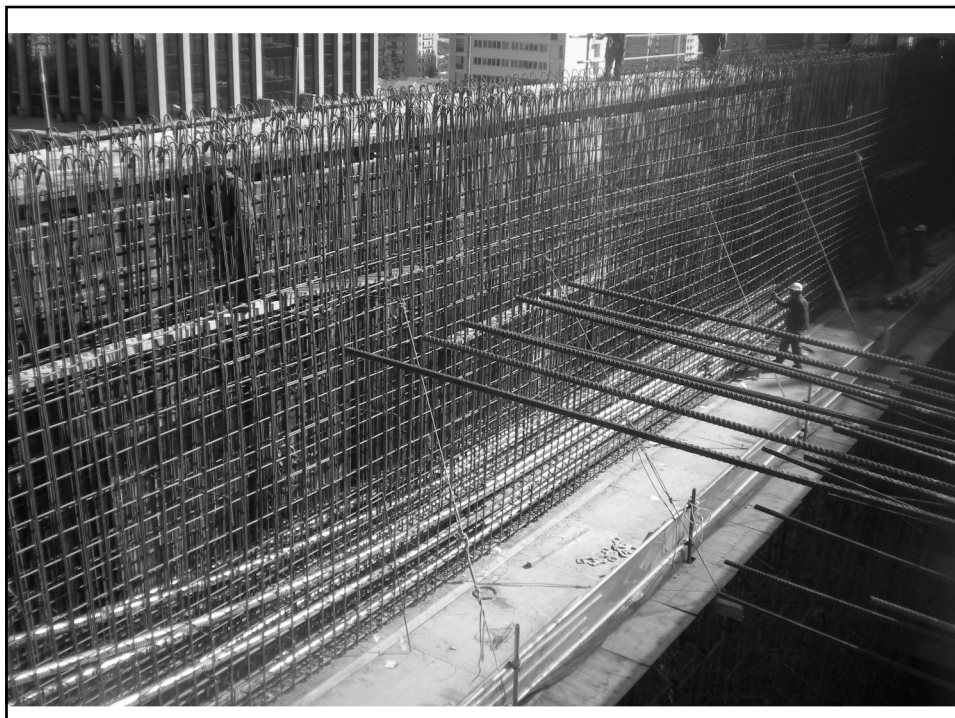

211

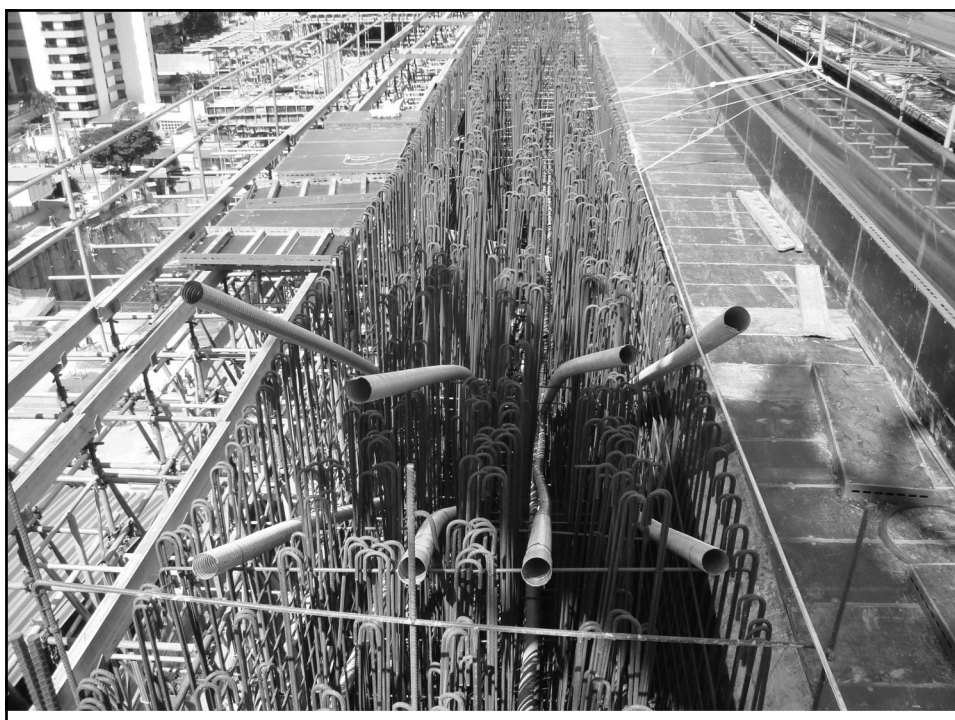

212

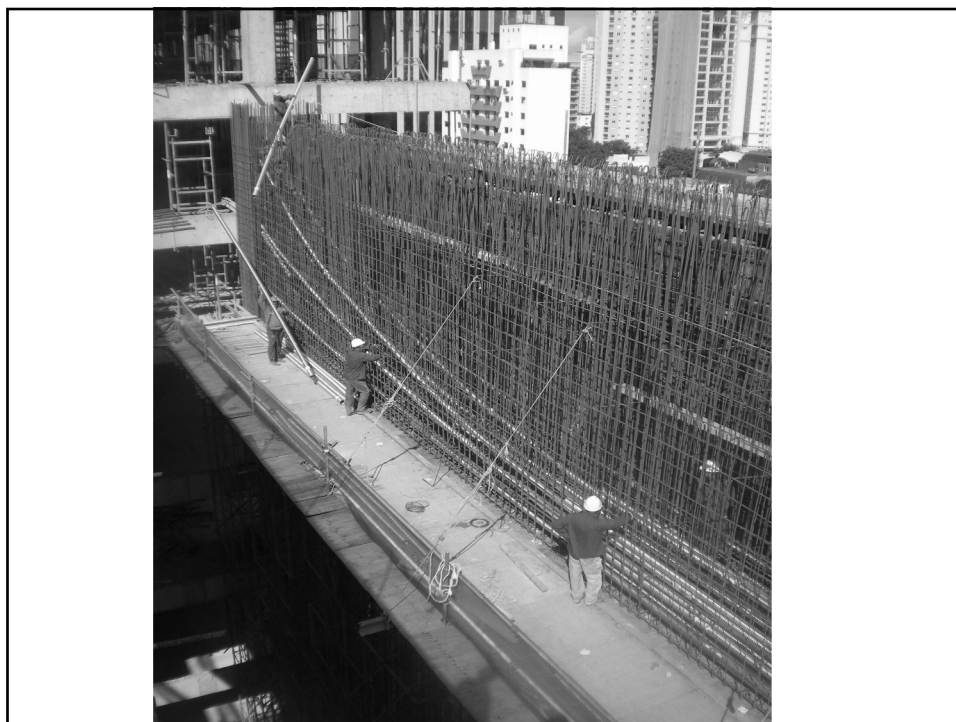

213



214



215



proteção contra a chuva

216



escoramento em balanço

217

Temperatura de lançamento

- ✓ **depende do consumo dos materiais (traço)**
- ✓ **depende do calor específico dos materiais**
- ✓ **depende da temperatura natural dos materiais**
- ✓ **depende da logística (fator tempo)***

** tempo associado a transporte e descarga do concreto*

dato de entrada mutável

218

218

Temperatura de lançamento

Material	Consumo kg/m³	Calor específico kcal/kg.°C	q=m.c (kcal/m³.°C)	T (°C)	Q (kcal/m³)
Cimento.CPII E-40	365	0,240	87,60	55	4818
Microssilica	29,6	0,200	5,92	40	236,8
Areia Artif.	525,3	0,200	105,06	22	2311,32
Areia Nat.	525,3	0,200	105,06	22	2311,32
Brita 0	336,5	0,200	67,30	22	1480,6
Brita 1	504,7	0,200	100,94	22	2220,68
Água	119,8	1,000	119,84	25	2996,1
Umidade Miúdo Art.	13,1	1,000	13,13	25	328,3
Umidade Miúdo Nat.	42,0	1,000	42,02	25	1050,6
Umidade Graúdo	0	1,000	0	25	0
Betoneira					2000
Total			646,88		19753,72
Transporte (Ganho)		10,0°C			
T Lançamento=		40,5°C			

sem gelo

219

219

Temperatura de lançamento

Material	Consumo kg/m³	Calor específico kcal/kg.°C	q=m.c (kcal/m³.°C)	Ti (°C)	Tf (°C)	Ti -Tf (°C)	Q (kcal/m³)
Cimento.CPII E-40	365	0,240	87,60	55	0	55	4818
Microssilica	29,6	0,200	5,92	40	0	40	236,8
Areia Artif.	525,3	0,200	105,06	22	0	22	2311,32
Areia Nat.	525,3	0,200	105,06	22	0	22	2311,32
Brita 0	336,5	0,200	67,3	22	0	22	1480,6
Brita 1	504,7	0,200	100,94	22	0	22	2220,68
Água	0	1,000	0	25	0	25	0
Umidade Miúdo Art.	13,1	1,000	13,13	25	0	25	328,31
Umidade Miúdo Nat.	42,0	1,000	42,02	25	0	25	1050,6
Umidade Graúdo	0	1,000	0	25	0	25	0
Gelo	119,8	0,500	59,92	0	0	0	0
Fusão Gelo	119,8	1,000	119,84	0	0	0	-9587,48
Gelo + Água	119,8	1,000	119,84	0	18	-18	-2157,18
Betoneira							2000
Total			826,65				5012,97
Transporte (Ganho)		10,0°C					
T Lançamento=		16,1°C					

com gelo: redução de 60%

220

220

Temperatura de lançamento

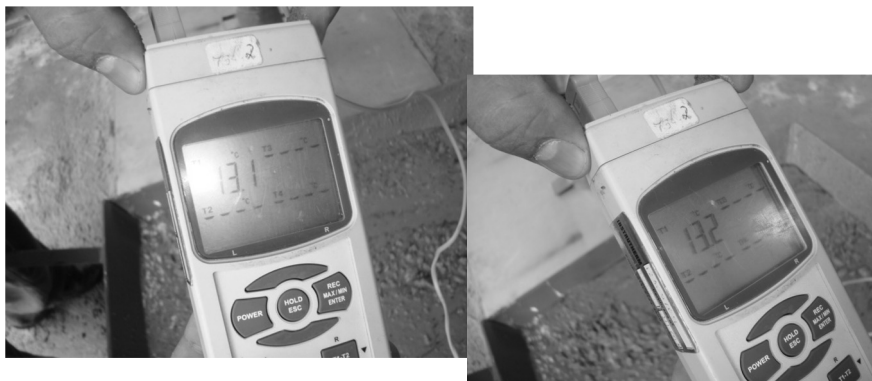

é possível ...

221

221

Acabamento



222



223



224



225



226

Comprometimento!

Do your best!

227



228